



CETECOM ICT Services GmbH  
Untertürkheimer Str. 6-10  
D-66117 Saarbrücken

## SatLabs Compliance/Interoperability Outline Test Plan

Revised Version 4 month after the start of the SatLabs Qualification Program

**Version 4.0**

### Contact Persons

#### Project Management

Uwe Kartmann: +49 681 598-8220

e-mail: [Uwe.Kartmann@ict.cetecom.de](mailto:Uwe.Kartmann@ict.cetecom.de)

#### Authors of this Document

Wilfried Latz: +49 681 598-8413

e-mail: [Wilfried.Latz@ict.cetecom.de](mailto:Wilfried.Latz@ict.cetecom.de)

Andreas Ehre: +49 681 598-8552

e-mail: [Andreas.Ehre@ict.cetecom.de](mailto:Andreas.Ehre@ict.cetecom.de)

<b>Implementation of the Common Test House for DVB-RCS Terminals</b>	Doc. No: T3-061-v1	
<b>ESA Contract No: 16878/02/NL/US</b>	Version: 1.0	
	Date: 2005-11-13	

## 0. Introduction

Beginning of 2004 the first version of the Outline Test Plan was published by the SatLabs Group. On basis of that Outline Test Plan the Common Test Bed (CTB) was developed which shall be used to perform the SatLabs Qualification Testing. The implementation specifics of the CTB as well as latest decisions in SatLabs on the SatLabs System Recommendations lead to the need to revise the Outline Test Plan. The version contained in this document

It is based on the following documents:

ETSI EN 301 790 V1.4.1 (2005-04)  
ETSI TR 101 790 V1.2.1 (2003-01)  
SatLabs System Recommendation V1.2.4

## 1. Document History

Version	Applied Changes	Date of Release	Editor
1.0	Revised version 4 month after the Start of the SatLabs Qualification Program	2005-11-13	W. Latz A. Ehre

This current version of the Outline Testplan replaces all preceding versions.

## 2. Status, Confidentiality and Distribution

Status	Confidentiality Level	Distribution
approved by project team	SatLabs Level	project team, SatLabs

**3. List of Content:**

0.	Introduction .....	2
1.	Document History .....	2
2.	Status, Confidentiality and Distribution .....	2
3.	List of Content: .....	3
4.	Definitions .....	4
4.1	Compliance Testing .....	4
4.2	Compliance Test Plan .....	5
4.3	PICS .....	5
4.4	PIXIT .....	5
5.	Protocol Implementation Conformance Statement (PICS) – Template for Terminals.....	6
6.	Protocol Implementation Extra Information for Testing (PIXIT) – Template for Terminals	8
7.	Test Case Selection Matrix (Basic Profile).....	9
8.	Test Case Selection Matrix (SatLabs Options) .....	11
9.	Test Plan for DVB-RCS Compliance .....	14
9.1	Forward Link Acquisition .....	15
9.2	Acquiring NCR Lock .....	30
9.3	CSC Burst Transmission .....	34
9.4	Logon Procedure .....	36
9.5	Coarse Synchronization Procedure.....	48
9.6	Fine Synchronization Procedure .....	55
7.7	Synchronization Maintenance Procedure .....	62
9.8	Forward Link Reception .....	68
9.9	Return Link Traffic Transmission & Capacity Requesting .....	70
9.10	Logoff.....	75
9.11	HOLD State .....	78
9.12	SI Tables .....	82
9.13	Frequency Hopping .....	134
9.14	Terminal Burst Time Plan .....	138
9.15	Satellite Position Table .....	142
9.16	Basic Application Testing .....	144
9.17	Variability .....	147
9.18	Wide Hopping .....	149
9.19	AVBDC .....	150
9.20	Dynamic MF-TDMA .....	152
9.21	Contention Sync .....	153
9.22	Section Packing .....	154
9.23	Timing Reference .....	155
9.24	NCR Payload .....	156
9.25	MMT .....	156

<b>Implementation of the Common Test House for DVB-RCS Terminals</b> <b>ESA Contract No: 16878/02/NL/US</b>	Doc. No: T3-061-v1 Version: 1.0 Date: 2005-11-13	
--	--	---

## 4. Definitions

### 4.1 Compliance Testing

The general definition of compliance is as follows:

*"Conformance/Compliance is exclusively considered in relation to a specific requirement or requirement document (e.g. specification, standard, guideline). Conformance/Compliance is the fact that a system or component meets the requirement(s) of a specification, standard or similar document.*

*Conformance/Compliance testing is the process of verifying that an implementation performs in accordance with a particular standard or specification. Conformance testing is exclusively concerned with the external behavior of an implementation. Service and functional behavior is tested in order to find logical errors and with this to ensure the prerequisites for interoperability.*

*Conformance/Compliance testing is not intended to be exhaustive, and a successfully passed test suite does not imply a 100-percent guarantee. But it does ensure, with a reasonable degree of confidence, that the implementation is consistent with its specification, and it does increase the probability that implementations will interwork."*

When Compliance and Compliance Testing is addressed for DVB-RCS Terminals one has to mask the requirements of the related standards with the definition above. In principle this would mean that

"Conformance/Compliance testing in terms of DVB-RCS shall demonstrate that a terminal fulfils the requirements of EN 301 790 standard."

However, it is necessary to define that sentence a bit closer with respect to the functionality which a terminal is expected to have in order to guarantee the proper behaviour when connected to DVB-RCS networks. With respect to the data transfer via DVB-RCS systems EN 301 790 does specify the lower layers of communications. Layer 3 is not addressed in EN 301 790.

With this, a meaningful definition – which also reduces the level of abstractness – could be as follows:

#### ***DVB-RCS Compliance***

***Compliance guarantees that a terminal can logon to the DVB-RCS network, maintain its synchronisation, make capacity requests as well use the corresponding capacity allocations. The compliance also covers the IP encapsulation, on both forward and return link, which means that the transport of IP datagrams from and to terminals is enabled.***

<b>Implementation of the Common Test House for DVB-RCS Terminals</b>	Doc. No: T3-061-v1	
<b>ESA Contract No: 16878/02/NL/US</b>	Version: 1.0	
	Date: 2005-11-13	

## 4.2 Compliance Test Plan

The compliance test plan is the collection of all the test cases which are reasonably assessed as relevant with respect to the basic compliance of DVB-RCS terminals. With the information on the implementation of functionalities in the terminal under test (PICS) the applicable test cases can be selected from this test plan.

## 4.3 PICS

A standard usually contains a huge amount of requirements. Often several options are raised in a standard. This leads to a situation where there are requirements which certainly do apply, further requirements which might apply and even requirements which do not apply to a specific device. The path through that labyrinth is given by a device itself - or in better words: by the information on the features which are implemented. This information is usually given in so-called "Implementation Compliance Statements" (ICS), or if specifically protocols are of interest in so-called "Protocol Implementation Conformance Statements" (PICS).

The PICS can be seen as a compliance list, in which for each feature of the standard an answer on its implementation is given. Each field of the PICS is linked with certain test cases. This means for instance, that if the compliance list says that "turbo coding" is implemented, all test cases dealing with turbo coding are to be tested.

In this document the link between PICS and applicable test cases is given in the test case definition, where the line "Applicability / PICS" can be found. Where that information field is left blank, the test case is obligatory.

## 4.4 PIXIT

As soon as it has been defined which test case is to be tested (based on the PICS) one can have a closer look into the test cases. Nearly all test cases require specific input parameters which might be different from device to device. Good examples for such parameters are "Population ID", "MAC address" etc.. Other parameters are expected to be constant from device to device (e.g. NCR\_min\_period).

All parameters which are required to perform a test are collected and communicated in form of a "**Protocol Implementation Extra Information for Testing**" (PIXIT). PIXIT is also a list of parameters. While the parameters and their syntax is well-defined, the value can vary within certain limits from case to case.

## 5. Protocol Implementation Conformance Statement (PICS) – Template for Terminals

The following Table forms a template to collect Protocol Implementation Conformance Statement (PICS) for a DVB-RCS terminal. Each of the fields given in the table must be filled in to create a specific testing profile. The information given in the filled PICS is basis for the selection of relevant test cases from the compliance test plan

**PICS Table**

PICS ID	PICS/Explanation	PICS
ATM_TRF	True if ATM TRF burst formatting is implemented	TRUE!
MPEG_TRF	True if MPEG TRF burst formatting is implemented	
CONV_RS	True if Convolutional and Reed Solomon coding is implemented	
TURBO	True if Turbo coding is implemented	TRUE!
COARSE_SYNC	True if Coarse Synchronization is supported	
FINE_SYNC	True if Fine Synchronization is supported	TRUE!
WAKE_UP	True if the RCST supports "wake up"	TRUE!
WIDE_HOPP_120	True if the RCST burst to burst frequency hopping range is 120 MHz	
FAST_HOPP	True if the RCST supports frequency hopping between adjacent time slots	
VBDC	True if the RCST supports VBDC capacity request class	TRUE!
RBDC	True if the RCST supports RBDC capacity request class	TRUE!
AVBDC	True if the RCST supports AVBDC capacity request class	
NEW_PERM	<del>True if the RCST does support new permutation as provided through TCT</del>	Not applicable TC deleted
CRC_SYNC	True if the RCST sends the SYNC burst with CRC	
PARALLEL_FWD_TRF	True if more than one receiver is implemented in the RCST	
DYNAMIC_MF-TDMA	True, if dynamic MF_TDMA is implemented	
ROUTE_ID	True, if an RCST can insert a route_ID in a SAC	
SECTION_PACKING	True, if an RCST supports DSM-CC section packing in both directions (forward link and return link)	
NCR_PAYLOAD	True, if an RCST supports decoding and interoperable use of the optional payload field in the NCR table as described in Appendix B of the SatLabs System Recommendations	
CONTENTION_SYNC	True, if an RCST supports the use of the contention SYNC slots	
MMT	True, if an RCST supports the Multicast Map Table signalling method	

<b>Implementation of the Common Test House for DVB-RCS Terminals</b>	Doc. No: T3-061-v1	
<b>ESA Contract No: 16878/02/NL/US</b>	Version: 1.0	
	Date: 2005-11-13	

## Legend

When describing the features of a terminal the following table should be used. For certain PICS IDs there is a recommendation given by the SatLabs group

- whether it is recommended to implement this feature – marked by the word “true” followed by an exclamation-mark (“true!”)
- whether it is recommended not to implement this feature – marked by the word “false” followed by an exclamation-mark (“false!”)

For those PICS IDs which are not marked by “true!” or “false!” it is under the discretion of the manufacturer whether the feature is implemented or not.

## 6. Protocol Implementation Extra Information for Testing (PIXIT) – Template for Terminals

The following Table forms a template to collect Protocol Implementation Extra Information for Testing (PIXIT) for a DVB-RCS terminal. Each of the fields given in the table must be filled in to create a specific test setup. The information given in the filled PIXIT is required by the test system to perform a specific test case. This information is to be provided by the manufacturer of an RCST before the testing for the SatLabs Qualification Program starts. Most of the initially defined PIXIT values (see first version of OTP) have been jointly defined in SatLabs Testing Parameter Ranges. Information to these values are only required if the RCST implementation deviates from the specified parameter ranges.

### Preliminary PIXIT Table

PIXIT_ID	PIXIT	Value
MAC_ADDR	MAC address of the RCST	
RCST_CAP_FIELD	24 bit field "RCST capability" in CSC burst	
INITIAL_IP_ADDR	IP address for the device management access (e.g. for accessing web page based management)	
LCT_PARAM	Parameters to access the device management console using a key based terminal application (e.g. Hyperterminal or similar)	
ACCESS_ACCOUNTS	Default Access Accounts to the device management. All usernames and passwords to configure the settings for the SatLabs Testing must be made available (e.g. installer account, network management account, admin user account, plain user account, etc.)	



## 7. Test Case Selection Matrix (Basic Profile)

Following table provides an overview on the applicable test cases when SatLabs basic profile is supported. All these tests should be performed using the SatLabs definition for the basic profile (ATM).

Test Case ID	Test Case Name	Applicable for Basic Profile (YES/NO)
FLA_001_01	NIT missing	YES
FLA_002_01	RMT missing	YES
FLA_003_01	PAT missing	YES
FLA_004_01	PMT missing	YES
FLA_005_01	Population_ID missing	YES
FLA_006_01	Transponder change 1	NO
FLA_007_01	Transponder change 2	NO
FLA_008_01	SCT missing	YES
FLA_009_01	FCT missing	YES
FLA_010_01	TCT missing	YES
FLA_011_01	SPT missing	YES
FLA_012_01	All tables received	YES
NCR_001_01	Variable NCR period	NO
NCR_002_01	NCR wrap-around	NO
NCR_003_01	NCR Loss	YES
CSC_001_01	CSC Burst	YES
LOGON_002_01	TIM permits transmission b)	YES
LOGON_003_01	Logon denied	YES
LOGON_004_01	Logon fails	YES
LOGON_005_01	Logon – no response a)	YES
LOGON_006_01	Logon – no response b)	YES
LOGON_007_01	Logon – no response c)	YES
LOGON_008_01	Logon – invalid response	YES
LOGON_009_01	Wake up	YES
FSYNC_001_01	Enter Fine Sync state	YES
FSYNC_002_01	Correction > Fine Sync threshold a)	YES
FSYNC_003_01	Correction > Fine Sync threshold b)	YES
FSYNC_004_01	No CMT response a)	YES
FSYNC_005_01	No CMT response b)	YES
MSYNC_001_01	Remaining in Fine Sync state	YES
MSYNC_002_01	Correction > Fine Sync threshold	YES
MSYNC_003_01	No CMT response a)	YES
MSYNC_004_01	No CMT response b)	YES
FLRECEPT_001_01	Forward Link Reception	YES
CRA_001_01	CRA Capacity Class	YES
VBDC_001_01	VBDC Capacity Class	YES
RBDC_001_01	RBDC Capacity Class	YES
LOGOFF_001_01	Hub initiated Logoff	YES
LOGOFF_002_01	RCST initiated Logoff	YES
HOLD_001_01	Transmit Disable	YES
HOLD_002_01	Remaining in HOLD State	YES

Test Case ID	Test Case Name	Applicable for Basic Profile (YES/NO)
HOLD_003_01	Transmit Enable	YES
SCT_001_01	Changes in SCT, superframe centre frequency	YES
SCT_002_01	Changes in SCT, frame centre frequency offset	YES
SCT_003_01	Changes in SCT, superframe duration	YES
SCT_004_01	Changes in SCT, number of frames	YES
FCT_001_01	Change in FCT, frame duration	YES
FCT_002_01	Change in FCT, total timeslot count	YES
FCT_003_01	Change in FCT, timeslot frequency offset	YES
FCT_004_01	Change in FCT, timeslot time offset	YES
TCT_001_01	Change in TCT, Code Rate, Turbo Code, TRF	YES
TCT_002_01	Change in TCT, Code_Rate, Turbo Code, CSC, SYNC	YES
TCT_003_01	Change in TCT, Inner_code_ordering natural, turbo code, TRF	YES
TCT_004_01	Change in TCT, Inner_code_ordering natural, turbo code, CSC and SYNC	YES
TCT_005_04	Change in TCT, Inner_code_ordering reverse, turbo code, TRF	obsolete
TCT_006_04	Change in TCT, Inner_code_ordering reverse, turbo code, CSC, SYNC	obsolete
TCT_010_01	Change in TCT, burst_start_offset, CSC, ACQ, SYNC	YES
TCT_011_01	Change in TCT, burst_start_offset, TRF	YES
TCT_012_01	Change in TCT, timeslot_payload_type, one ATM cell	YES
TCT_013_01	Change in TCT, timeslot_payload_type, two ATM cells	YES
TCT_014_01	Change in TCT, timeslot_payload_type, four ATM cells	YES
TCT_016_01	Change in TCT, symbol_rate; CSC, ACQ, SYNC	YES
TCT_017_01	Change in TCT, symbol_rate; TRF	YES
TCT_018_01	Change in TCT, Preamble_composition; CSC, ACQ, SYNC	YES
TCT_020_01	Change in TCT, Preamble_composition; TRF with ATM	YES
TCT_021_01	Change in TCT,Default permutation, Turbo code, CSC, SYNC	YES
TCT_022_01	Change in TCT,Default permutation, Turbo code, TRF	YES
TCTTC_001_01	Change in TCT, Outer_Coding no CRC no RS, Turbo, TRF	YES
TCTTC_003_01	Change in TCT, Outer_Coding no CRC no RS, Turbo, SYNC	YES
TCTTC_004_01	Change in TCT, Outer_Coding CRC no RS, Turbo, CSC	YES
TEST_CONF1_001_01	Low data rate, one slot in each frame	YES
TEST_CONF2_001_01	Medium data rate, some slots per frame	YES
TEST_CONF3_001_01	Higher data rate, several slots per frame	YES
TEST_CONF4_001_01	Maximum data rate, all slots in each superframe	YES

Test Case ID	Test Case Name	Applicable for Basic Profile (YES/NO)
FHOP_001_01	Change in TBTP; slow hopping; TRF	YES
FHOP_003_01	Change in TBTP; narrow hopping range; TRF	YES
TBTP_001_01	Change in TBTP; Assignment_Count	YES
TBTP_002_01	Change in TBTP; Assignment_Type; one time	YES
TBTP_003_01	Change in TBTP; Assignment_Type; repeating assignment	obsolete
SPT_001_01	Change in SPT; satellite coordinates	YES
APP_001_01	Verify basic IP connectivity by performing ping in both directions	YES
APP_002_01	FTP File Transfer	YES
OTF_001_01	On the fly variability, number of CSC slots	YES
TIME_REF_001_01	Variation in FL, correct delay compensation	YES

The test cases shaded in grey are currently not supported. Nevertheless, these test cases will remain defined as they are. As soon as the test system is upgraded and supporting these test cases they will be part of the SatLabs Qualification Testing.

## 8. Test Case Selection Matrix (SatLabs Options)

Following table provides an overview on the applicable test cases when SatLabs recommended options are supported. All these tests, except the tests foreseen for MPEG option, should be performed using ATM as traffic burst type.

Test Case ID	Test Case Name	Applicable for following options
FLA_012_01	All tables received	MPEG
CSC_001_01	CSC Burst	MPEG
LOGON_008_01	Logon – invalid response	MPEG
LOGON_009_01	Wake up	MPEG
FLRECEPT_001_01	Forward Link Reception	MPEG
CRA_001_01	CRA Capacity Class	MPEG
VBDC_001_01	VBDC Capacity Class	MPEG
RBDC_001_01	RBDC Capacity Class	MPEG
SCT_001_01	Changes in SCT, superframe centre frequency	MPEG
SCT_002_01	Changes in SCT, frame centre frequency offset	MPEG
SCT_003_01	Changes in SCT, superframe duration	MPEG
SCT_004_01	Changes in SCT, number of frames	MPEG
FCT_001_01	Change in FCT, frame duration	MPEG
FCT_002_01	Change in FCT, total timeslot count	MPEG
FCT_003_01	Change in FCT, timeslot frequency offset	MPEG
FCT_004_01	Change in FCT, timeslot time offset	MPEG
TCT_001_01	Change in TCT, Code Rate, Turbo Code, TRF	MPEG
TCT_002_01	Change in TCT, Code_Rate, Turbo Code, CSC, SYNC	MPEG
TCT_003_01	Change in TCT, Inner_code_ordering natural, turbo code, TRF	MPEG

Test Case ID	Test Case Name	Applicable for following options
TCT_004_01	Change in TCT, Inner_code_ordering natural, turbo code, CSC and SYNC	MPEG
TCT_010_01	Change in TCT, burst_start_offset, CSC, ACQ, SYNC	MPEG
TCT_011_01	Change in TCT, burst_start_offset, TRF	MPEG
TCT_015_01	Change in TCT, timeslot_payload_type, MPEG traffic	MPEG
TCT_016_01	Change in TCT, symbol_rate; CSC, ACQ, SYNC	MPEG
TCT_017_01	Change in TCT, symbol_rate; TRF	MPEG
TCT_018_01	Change in TCT, Preamble_composition; CSC, ACQ, SYNC	MPEG
TCT_019_01	Change in TCT, Preamble_composition; TRF with MPEG	MPEG
TCT_021_01	Change in TCT, Default permutation, Turbo code, CSC, SYNC	MPEG
TCTTC_001_01	Change in TCT, Outer_Coding no CRC no RS, Turbo, TRF	MPEG
TCTTC_003_01	Change in TCT, Outer_Coding <u>no</u> CRC no RS, Turbo, SYNC	MPEG
TCTTC_004_01	Change in TCT, Outer_Coding CRC no RS, Turbo, CSC	MPEG
TEST_CONF1_001_01	Low data rate, one slot in each frame	MPEG
TEST_CONF2_001_01	Medium data rate, some slots per frame	MPEG
TEST_CONF3_001_01	Higher data rate, several slots per frame	MPEG
TEST_CONF4_001_01	Maximum data rate, all slots in each superframe	MPEG
FHOP_001_01	Change in TBTP; slow hopping; TRF	MPEG
FHOP_003_01	Change in TBTP; narrow hopping range; TRF	MPEG
TBTP_001_01	Change in TBTP; Assignment_Count	MPEG
TBTP_002_01	Change in TBTP; Assignment_Type; one time	MPEG
APP_001_01	Verify basic IP connectivity by performing ping in both directions	MPEG
APP_002_01	FTP File Transfer	MPEG
TCT_008_01	Change in TCT, Code rate, Convolutional, TRF	CONV-RS
TCT_009_01	Change in TCT, Code rate, Convolutional, CSC, SYNC	CONV-RS
TCTCC_001_01	Change in TCT, Outer_Coding RS no CRC, convolutional, TRF	CONV-RS
TCTCC_002_01	Change in TCT, Outer_Coding RS <u>and</u> CRC, convolutional, SYNC	CONV-RS
TCTCC_003_01	Change in TCT, Outer_Coding RS <u>no</u> CRC, convolutional, SYNC	CONV-RS
TCTCC_004_01	Change in TCT, Outer_Coding CRC <u>no</u> RS, convolutional, CSC	CONV-RS
LOGON_001_01	TIM permits transmission a)	CSYNC

Test Case ID	Test Case Name	Applicable for following options
CSYNC_001_01	Enter Fine sync state	CSYNC
CSYNC_002_01	Correction > Coarse Sync threshold a)	CSYNC
CSYNC_003_01	Correction > Coarse Sync threshold b)	CSYNC
CSYNC_004_01	No ACQ response a)	CSYNC
CSYNC_005_01	No ACQ response b)	CSYNC
WIDE_HOPP_120_001_01	Wide Hopping Range (120MHz)	WIDE_HOPP_120
FHOP_002_01	Change in TBTP; fast hopping; TRF	FAST_HOPP
AVBDC_001_01	AVBDC Capacity Class	AVBDC
DYNAMIC_MF-TDMA_001_01	Dynamic MF-TDMA	DYNAMIC_MF-TDMA
TCT_007_01	Change in TCT, New_permutation, Turbo Code, TRF	NEW_PERMUTATION
TCT_023_01	Change in TCT, Route_ID	ROUTE_ID
CONTENTION_SYNC_001_01	Contention Sync	CONTENTION_SYNC
SEC_PACK_001_01	DSM-CC; Section Packing	SECTION_PACKING
Not yet available (under development)	Not yet available (under development) see Note**	NCR_PAYLOAD
Not yet available (under development)	Not yet available (under development) see Note**	MMT

Note\*\*: The test cases for this option are currently under development. At the time of releasing this document it was not clear how many single TCs for this options need to be created.

## 9. Test Plan for DVB-RCS Compliance

The test plan which is described in this section is based on the requirements which are defined in EN 301 790. With respect to the compliance definition as given in Chapter 4, a set of test cases has been chosen to form this compliance test plan. The test plan is structured in several sections, each dealing with a specific functionality.

### Structure of the test plan

	Test Section	Number of Test Cases in Section
8.1	Forward Link Acquisition	12
8.2	Acquiring NCR Lock	3
8.3	CSC Burst Transmission	1
8.4	Logon Procedure	9
8.5	Coarse Synchronization Procedure	5
8.6	Fine Synchronization Procedure	5
8.7	Synchronization Maintenance Procedure	4
8.8	Forward Link Reception	1
8.9	Return Link Traffic Transmission & Capacity Requesting	4
8.10	Logoff	2
8.11	HOLD State	3
8.12	SI Tables	43 (of which 3 are obsolete)
8.13	Frequency Hopping	3
8.14	Terminal Burst Time Plan	3 (of which 1 is obsolete)
8.15	Satellite Position Table	1
8.16	Basic Application Testing	2
8.17	Variability	1
8.18	Wide Hopping	1
8.19	AVBDC	1
8.20	Dynamic MF-TDMA	1
8.21	Contention Sync	1
8.22	Section Packing	1
8.23	Timing reference	1

**Total:**

**108 (of which 4 are obsolete)**

<b>Implementation of the Common Test House for DVB-RCS Terminals</b>	Doc. No: T3-061-v1	
<b>ESA Contract No: 16878/02/NL/US</b>	Version: 1.0	
	Date: 2005-11-13	

## 9.1 Forward Link Acquisition

This section investigates the proper acquisition of the forward link, when a terminal is connected to the network. By passing the tests in this section it is ensured that the terminal does not send any signal to the network unless all required information has been derived from the forward link. Furthermore, it is verified that the terminal is capable of acquiring the forward link even if it is forced to change transponders for collecting all required information.

### Reason for having this test

Beside the pure fact, that a terminal needs to acquire the forward link to receive user data, in satellite interactive networks it also needs the complete network information to set-up a return link. All signalling from the network to the terminal must be encapsulated in the forward link. As at the start of the communication process the terminal has no connection to the network, it first must read out the network information tables and program tables. Only if all the tables are received and interpreted correctly, a return link can be initialised. For sure, to initially receive any signal the RCST needs an information on the transponder which is used to broadcast the required information. That transponder might change from time to time or when a terminal is switched from one hub/network to another. A change in configuration of the initial transponder values needs to be realised when a terminal is powered up and connected to the network. Otherwise, no information on the network and its structure (including the return link frame and time-slot structure) could be received by the terminal.

This section consists of 11 single test cases:

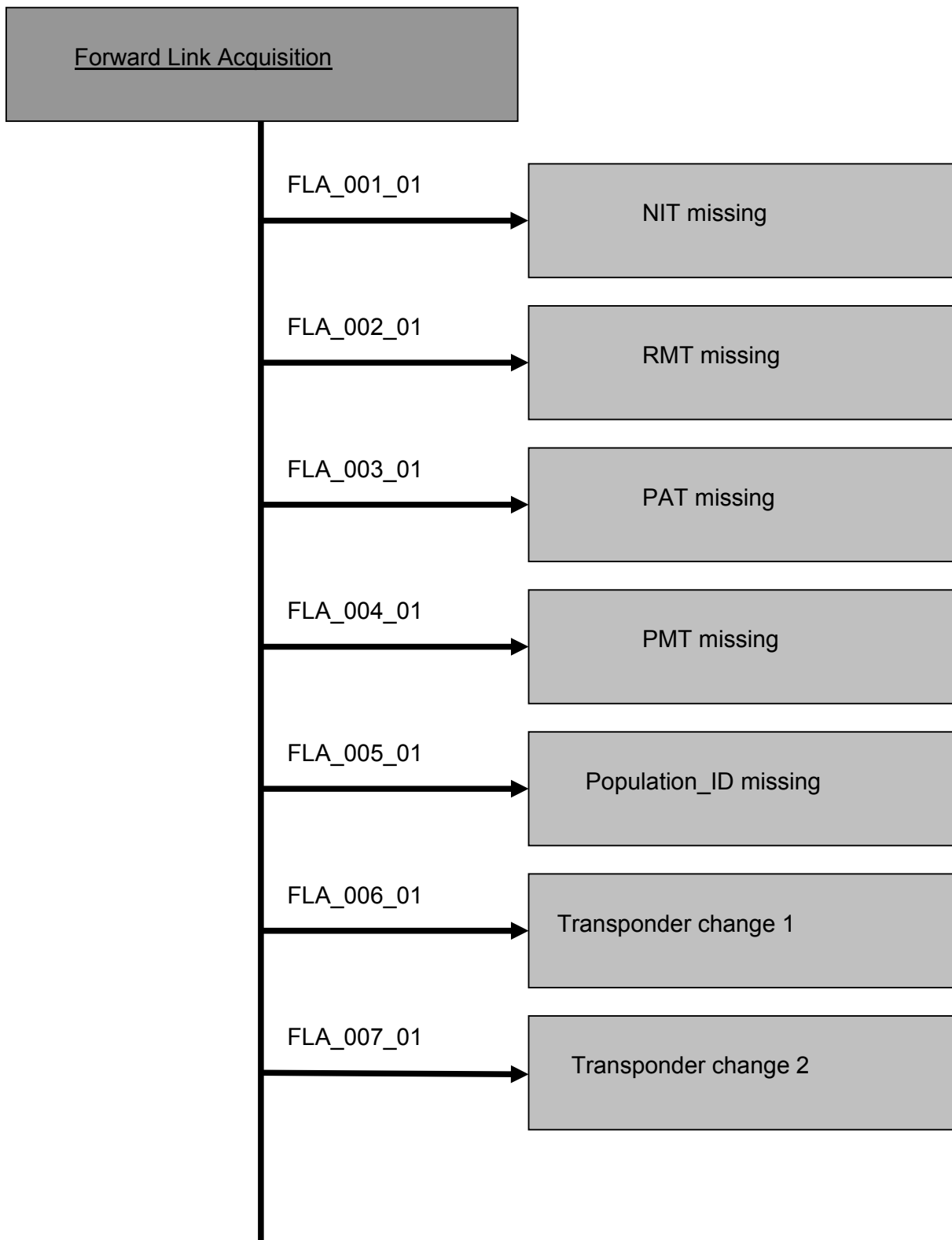



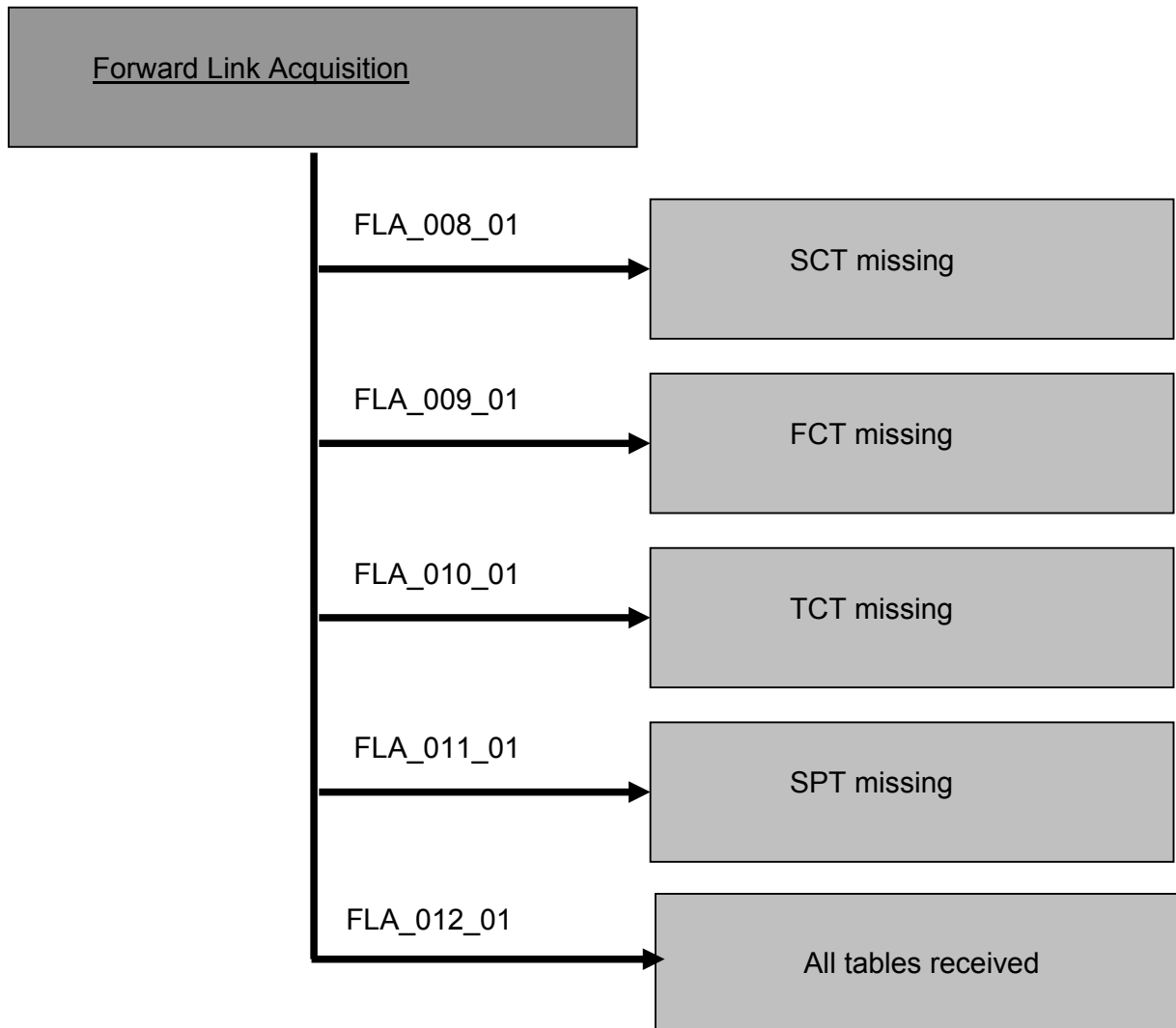



<b>Implementation of the Common Test House for DVB-RCS Terminals</b>	Doc. No: T3-061-v1	
<b>ESA Contract No: 16878/02/NL/US</b>	Version: 1.0	
	Date: 2005-11-13	

Test Case ID	FLA_001_01	
Test Case Name	NIT missing	
EN 301790 Reference	8.5.5.11	
Objective / Test Purpose	Verify that the RCST does not acquire the forward link when NIT is missing. RMT, PAT and PMT are correctly broadcast.	
Applicability / PICS	-	
Initial RCST State	Off/Stand-by	
Expected Final RCST State	Off/Stand-by	
Test Method	Step	Description
	1	Test system does not transmit NIT, all other SI tables necessary to acquire the forward link are correctly distributed
	2	Initiate RCST Logon procedure
	3	Test system verifies RCST activities and monitors return link activities
PASS/FAIL Criteria	<ul style="list-style-type: none"> <li>• RCST does not proceed with Logon procedure.</li> <li>• RCST does not transmit any burst.</li> </ul>	
Remarks	Reaction as provided by the terminal to be noted.	

<b>Implementation of the Common Test House for DVB-RCS Terminals</b>	Doc. No: T3-061-v1	
<b>ESA Contract No: 16878/02/NL/US</b>	Version: 1.0	
	Date: 2005-11-13	

Test Case ID	FLA_002_01	
Test Case Name	RMT missing	
EN 301790 Reference	8.5.5.11	
Objective / Test Purpose	Verify that the RCST does not acquire the forward link when RMT is missing. NIT, PAT and PMT are correctly broadcast.	
Applicability / PICS	-	
Initial RCST State	Off/Stand-by	
Expected Final RCST State	Off/Stand-by	
Test Method	Step	Description
	1	Test system does not transmit RMT, all other SI tables necessary to acquire the forward link are correctly distributed
	2	Initiate RCST Logon procedure
	3	Test system verifies RCST activities and monitors return link activities
PASS/FAIL Criteria	<ul style="list-style-type: none"> <li>• RCST does not proceed with Logon procedure.</li> <li>• RCST does not transmit any burst.</li> </ul>	
Remarks	Reaction as provided by the terminal to be noted.	

<b>Implementation of the Common Test House for DVB-RCS Terminals</b>	Doc. No: T3-061-v1	
<b>ESA Contract No: 16878/02/NL/US</b>	Version: 1.0	
	Date: 2005-11-13	

Test Case ID	FLA_003_01	
Test Case Name	PAT missing	
EN 301790 Reference	8.5.5.11	
Objective / Test Purpose	Verify that the RCST does not acquire the forward link when PAT is missing. NIT, RMT and PMT are correctly broadcast.	
Applicability / PICS	-	
Initial RCST State	Off/Stand-by	
Expected Final RCST State	Off/Stand-by	
Test Method	Step	Description
	1	Test system does not transmit PAT, all other SI tables necessary to acquire the forward link are correctly distributed
	2	Initiate RCST Logon procedure
	3	Test system verifies RCST activities and monitors return link activities
PASS/FAIL Criteria	<ul style="list-style-type: none"> <li>• RCST does not proceed with Logon procedure.</li> <li>• RCST does not transmit any burst.</li> </ul>	
Remarks	Reaction as provided by the terminal to be noted.	

<b>Implementation of the Common Test House for DVB-RCS Terminals</b> <b>ESA Contract No: 16878/02/NL/US</b>	Doc. No: T3-061-v1 Version: 1.0 Date: 2005-11-13	
--	--	---

Test Case ID	FLA_004_01	
Test Case Name	PMT missing	
EN 301790 Reference	8.5.5.11	
Objective / Test Purpose	Verify that the RCST does not acquire the forward link when PMT is missing. NIT, RMT and PAT are correctly broadcast.	
Applicability / PICS	-	
Initial RCST State	Off/Stand-by	
Expected Final RCST State	Off/Stand-by	
Test Method	Step	Description
	1	Test system does not transmit PMT, all other SI tables necessary to acquire the forward link are correctly distributed
	2	Initiate RCST Logon procedure
	3	Test system verifies RCST activities and monitors return link activities
PASS/FAIL Criteria	<ul style="list-style-type: none"> <li>• RCST does not proceed with Logon procedure.</li> <li>• RCST does not transmit any burst.</li> </ul>	
Remarks	Reaction as provided by the terminal to be noted.	

Test Case ID	FLA_005_01	
Test Case Name	Population_ID missing	
EN 301790 Reference	8.5.5.11	
Objective / Test Purpose	Verify that the RCST does not acquire the forward link when its population_ID is not covered by the relevant linkage descriptor of the RMT.	
Applicability / PICS	-	
Initial RCST State	Off/Stand-by	
Expected Final RCST State	Off/Stand-by	
Test Method	Step	Description
	1	Test system transmits all SI tables necessary to acquire the forward link are correctly distributed, but the RMT which is provided does not contain the population_ID that is configured in the RCST.
	2	Initiate RCST Logon procedure
	3	Test system verifies RCST activities and monitors return link activities
PASS/FAIL Criteria	<ul style="list-style-type: none"> <li>• RCST does not proceed with Logon procedure.</li> <li>• RCST does not transmit any burst.</li> </ul>	
Remarks	<p>The list of population_IDs is covered by the linkage descriptor and distributed as part of the RMT</p> <p>Reaction as provided by the terminal to be noted.</p>	

<b>Implementation of the Common Test House for DVB-RCS Terminals</b>	Doc. No: T3-061-v1	
<b>ESA Contract No: 16878/02/NL/US</b>	Version: 1.0	
	Date: 2005-11-13	

Test Case ID	FLA_006_01	
Test Case Name	Transponder change 1	
EN 301790 Reference	8.5.5.11	
Objective / Test Purpose	Verify that the RCST is able to acquire the forward link even if the satellite delivery descriptor, transmitted in the NIT, forces the RCST to change the transponder (retune) to receive the RMT.	
Applicability / PICS	-	
Initial RCST State	Off/Stand-by	
Expected Final RCST State	Off/Stand-by	
Test Method	Step	Description
	1	Test system distributes NIT including the satellite_delivery_descriptor which identifies the frequency where the transponder is located that carries the RMT.
	2	Test system issues default value for frequency in satellite_delivery_descriptor as specified in step 1
	3	Start RCST logon procedure
	4	Initiate IP traffic from Host PC at RCST side
	5	Test system verifies RCST's transmit activities. Test system verifies that the RCST is transmitting in each allocated timeslot.
	6	Initiate RCST logoff
	7	Change frequency which identifies the location of the transponder that carries the RMT in the satellite_delivery_descriptor
	8	Proceed with step 3 until procedure is done for lowest and highest value for the frequency described in step 7
	9	End
PASS/FAIL Criteria	<ul style="list-style-type: none"> <li>• Test procedure is fulfilled.</li> <li>• RCST has achieved fine sync state in step 5.</li> <li>• RCST has set fine sync achieved flag in M&amp;C message of the SAC field in step 5.</li> <li>• RCST's burst synchronization accuracy shall be within 50% of a symbol period in step 5</li> </ul>	
Remarks	SYNC_achieved_time_threshold and SYNC_achieved_frequency threshold are distributed in SYNC assign descriptor. The test should be performed with worst case values for SYNC_achieved_time_threshold and SYNC_achieved_frequency threshold. The test has to be performed with max. value for symbol_rate.	

Test Case not yet supported

<b>Implementation of the Common Test House for DVB-RCS Terminals</b>	Doc. No: T3-061-v1 Version: 1.0	
<b>ESA Contract No: 16878/02/NL/US</b>	Date: 2005-11-13	

Test Case ID	FLA_007_01	
Test Case Name	Transponder change 2	
EN 301790 Reference	8.5.5.11	
Objective / Test Purpose	Verify that the RCST is able to acquire the forward link even if the satellite forward link descriptor, transmitted in the RMT, forces the RCST to change the transponder (retune) to receive the PAT and PMT..	
Applicability / PICS	-	
Initial RCST State	Off/Stand-by	
Expected Final RCST State	Off/Stand-by	
Test Method	Step	Description
	1	Test system distributes RMT including the satellite_delivery_descriptor which identifies the frequency where the transponder is located that carries the PAT and PMT.
	2	Test system issues default value for frequency in satellite_delivery_descriptor as specified in step 1
	3	Start RCST logon procedure
	4	Initiate IP traffic from Host PC at RCST side
	5	Test system verifies RCST`s transmit activities. Test system verifies that the RCST is transmitting in each allocated timeslot.
	6	Initiate RCST logoff
	7	Change frequency which identifies the location of the PAT and PMT transponder in the satellite_delivery_descriptor
	8	Proceed with step 3 until procedure is done for lowest and highest value for the frequency described in step 7
	9	End
PASS/FAIL Criteria	<ul style="list-style-type: none"> <li>• Test procedure is fulfilled.</li> <li>• RCST has achieved fine sync state in step 5.</li> <li>• RCST has set fine sync achieved flag in M&amp;C message of the SAC field in step 5.</li> <li>• RCST`s burst synchronization accuracy shall be within 50% of a symbol period in step 5</li> </ul>	
Remarks	SYNC_achieved_time_threshold and SYNC_achieved_frequency threshold are distributed in SYNC assign descriptor. The test should be performed with worst case values for SYNC_achieved_time_threshold and SYNC_achieved_frequency threshold. The test has to be performed with max. value for symbol_rate.	

Test Case not yet supported



<b>Implementation of the Common Test House for DVB-RCS Terminals</b>	Doc. No: T3-061-v1 Version: 1.0	
<b>ESA Contract No: 16878/02/NL/US</b>	Date: 2005-11-13	

Test Case ID	FLA_008_01	
Test Case Name	SCT missing	
EN 301790 Reference	8.5.5.11	
Objective / Test Purpose	Verify that the RCST does not proceed with Logon procedure as long as SCT is missing.	
Applicability / PICS	-	
Initial RCST State	Off/Stand-by	
Expected Final RCST State	Off/Stand-by	
Test Method	Step	Description
	1	Test system does not transmit SCT, all other SI tables necessary to acquire the forward link are correctly distributed
	2	Initiate RCST Logon procedure
	3	Test system verifies RCST activities and monitors return link activities
PASS/FAIL Criteria	<ul style="list-style-type: none"> <li>• RCST does not proceed with Logon procedure.</li> <li>• RCST does not transmit any burst.</li> </ul>	
Remarks	Reaction as provided by the terminal to be noted.	

<b>Implementation of the Common Test House for DVB-RCS Terminals</b>	Doc. No: T3-061-v1	
<b>ESA Contract No: 16878/02/NL/US</b>	Version: 1.0	
	Date: 2005-11-13	

Test Case ID	FLA_009_01	
Test Case Name	FCT missing	
EN 301790 Reference	8.5.5.11	
Objective / Test Purpose	Verify that the RCST does not proceed with Logon procedure as long as FCT is missing.	
Applicability / PICS	-	
Initial RCST State	Off/Stand-by	
Expected Final RCST State	Off/Stand-by	
Test Method	Step	Description
	1	Test system does not transmit FCT, all other SI tables necessary to acquire the forward link are correctly distributed
	2	Initiate RCST Logon procedure
	3	Test system verifies RCST activities and monitors return link activities
PASS/FAIL Criteria	<ul style="list-style-type: none"> <li>• RCST does not proceed with Logon procedure.</li> <li>• RCST does not transmit any burst.</li> </ul>	
Remarks	Reaction as provided by the terminal to be noted.	

<b>Implementation of the Common Test House for DVB-RCS Terminals</b>	Doc. No: T3-061-v1	
<b>ESA Contract No: 16878/02/NL/US</b>	Version: 1.0	
	Date: 2005-11-13	

Test Case ID	FLA_010_01	
Test Case Name	TCT missing	
EN 301790 Reference	8.5.5.11	
Objective / Test Purpose	Verify that the RCST does not proceed with Logon procedure as long as TCT is missing.	
Applicability / PICS	-	
Initial RCST State	Off/Stand-by	
Expected Final RCST State	Off/Stand-by	
Test Method	Step	Description
	1	Test system does not transmit TCT, all other SI tables necessary to acquire the forward link are correctly distributed
	2	Initiate RCST Logon procedure
	3	Test system verifies RCST activities and monitors return link activities
PASS/FAIL Criteria	<ul style="list-style-type: none"> <li>• RCST does not proceed with Logon procedure.</li> <li>• RCST does not transmit any burst.</li> </ul>	
Remarks	Reaction as provided by the terminal to be noted.	

Test Case ID	FLA_011_01	
Test Case Name	SPT missing	
EN 301790 Reference	8.5.5.11	
Objective / Test Purpose	Verify that the RCST does not proceed with Logon procedure as long as SPT is missing.	
Applicability / PICS	-	
Initial RCST State	Off/Stand-by	
Expected Final RCST State	Off/Stand-by	
Test Method	Step	Description
	1	Test system does not transmit SPT, all other SI tables necessary to acquire the forward link are correctly distributed
	2	Initiate RCST Logon procedure
	3	Test system verifies RCST activities and monitors return link activities
PASS/FAIL Criteria	<ul style="list-style-type: none"> <li>• RCST does not proceed with Logon procedure.</li> <li>• RCST does not transmit any burst.</li> </ul>	
Remarks	<p>The nominal satellite position is not distributed in the NIT.</p> <p>Reaction as provided by the terminal to be noted.</p>	

<b>Implementation of the Common Test House for DVB-RCS Terminals</b>	Doc. No: T3-061-v1 Version: 1.0	
<b>ESA Contract No: 16878/02/NL/US</b>	Date: 2005-11-13	

Test Case ID	FLA_012_01	
Test Case Name	All tables received	
EN 301790 Reference	8.5.5.11	
Objective / Test Purpose	Verify that the RCST proceeds with Logon procedure after having received NIT, RMT, PAT, PMT, SCT, FCT, TCT, TIM-B and SPT	
Applicability / PICS	-	
Initial RCST State	Off/Stand-by	
Expected Final RCST State	Ready for Fine/Coarse sync state	
Test Method	Step	Description
	1	Test system transmits NIT, RMT, PAT, PMT, SCT, FCT, TCT, TIM-B and SPT
	2	Initiate RCST Logon procedure
	3	RCST reports the correct reception of these tables, e.g. dump tables
PASS/FAIL Criteria	<ul style="list-style-type: none"> <li>RCST has correctly received all tables in step 3</li> </ul>	
Remarks		

## 9.2 Acquiring NCR Lock

In this section it is verified, that the terminal is capable of handling various NCR events without causing problems in the network. The terminal may be impacted by various NCR periods or NCR packet losses and also NCR counter wrap-around. These test cases investigate the proper reaction of the terminal specifically on NCR impacts.

### Reason for having this test

In networks which are using shared media, there are initially two options to organise traffic from multiple sources. While LAN techniques use tokens or collision detection, satellite networks need to use another method. As the latency of the transmission path is high a potential collision cannot be detected, all terminals need to be synchronised. Pre-condition for any type of synchronisation is a common clock basis. This basis might be derived from any clocked signal, however, that clock is a relative clock, as it is shifted by the signal delay. When synchronising the return channel in this distributed shared media the grade of synchronisation must even be higher. Without having a common clock basis in form of a countable value like the NCR, a synchronisation is nearly impossible. With respect to this value, it is not enough to transmit the NCR, it is also required to guarantee that transmission is ceased when NCR is not available anymore.

**This section consists of 3 single test cases:**

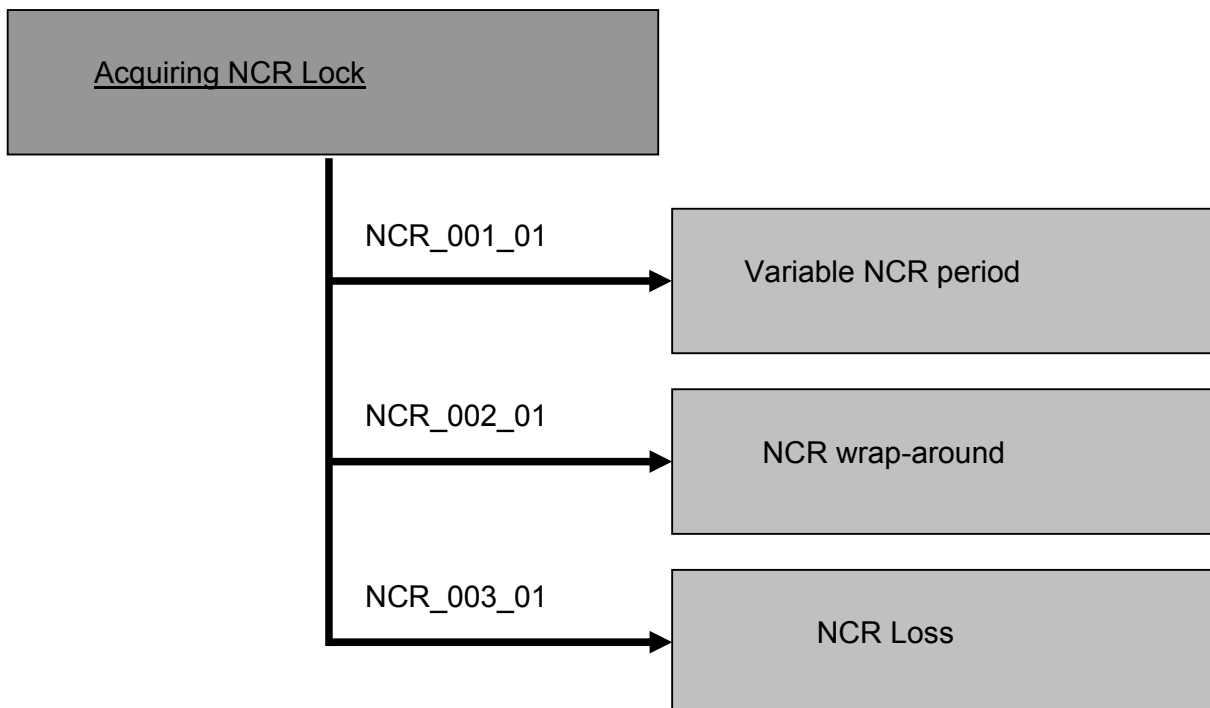

Test Case ID	NCR_001_01 (fine Synchronisation)	
Test Case Name	Variable NCR period	
EN 301790 Reference	7.7.3, 8.3.5	
Objective / Test Purpose	Verify that the RCST is capable of handling various NCR update rates (200 times up to 10 times per second), the RCST shall not loose NCR synchronization.	
Applicability / PICS	-	
Initial RCST State	Fine Sync state	
Expected Final RCST State	Fine Sync state	
Test Method	Step	Description
	1	timer_value = (10 minutes)
	2	Test system issues the NCR with an update rate of 200 times/second
	3	Initiate IP traffic from RCST
	4	Preset timer with timer_value, start timer
	5	Test system verifies RCST's transmit activities.
	6	RCST should transmit in allocated TRF slots
	7	Repeat step 5 to step 6 until timer expires
	8	Cancel IP traffic from RCST
	9	Update rate for the NCR is reduced in the CTB down to 50 times/second
	10	Initiate IP traffic from RCST
	11	Preset timer with timer_value, start timer
	12	Test system verifies RCST's transmit activities.
	13	RCST should transmit in allocated TRF slots
	14	Repeat step 12 to step 13 until timer expires
	15	Cancel IP traffic from RCST
	16	Update rate for the NCR is reduced in the CTB down to 50 times/second
	17	Initiate IP traffic from RCST
	18	Preset timer with timer_value, start timer
	19	Test system verifies RCST's transmit activities.
	20	RCST should transmit in allocated TRF slots
	21	Repeat step 12 to step 13 until timer expires
	22	End
PASS/FAIL Criteria	<ul style="list-style-type: none"> <li>• Test procedure is fulfilled.</li> <li>• RCST does not leave fine sync state in step 5, in step 12 or in step 19.</li> <li>• RCST transmits IP traffic in allocated TRF slots.</li> </ul>	
Remarks	The test has to be performed with max. value for symbol_rate. The test has to be performed with 200 times/second, 50 times/second and 10 times/second as update rate for NCR.	

Test Case not yet supported

Test Case ID	NCR_002_01	
Test Case Name	NCR wrap-around	
EN 301790 Reference	8.5.5.6.2	
Objective / Test Purpose	Verify that the RCST does not loose NCR synchronization even if the broadcast NCR does wrap-around to 0.	
Applicability / PICS	-	
Initial RCST State	Off/Stand-by	
Expected Final RCST State	Off/Stand-by	
Test Method	Step	Description
	1	timer_value=(10 minutes)
	2	Test system presets NCR counter value near the wrap-around point, so that NCR counter does wrap around during the session when a TRF link is established between RCST and test system.
	3	Test system issues the NCR with an update rate of 200 times/second
	4	Start RCST logon procedure
	5	Initiate IP traffic from Host PC at RCST side
	6	Test system verifies that the NCR clock wrap-around occurs after the moment the RCST has reached the fine sync state
	7	If NCR clock wrap-around has occurred, preset timer with timer_value, start timer proceed with step 8 else wait for NCR clock wrap-around
	8	Test system verifies RCST's transmit activities. Test system verifies that the RCST is transmitting in allocated timeslots.
	9	Repeat step 8 until timer expires
	10	Initiate RCST logoff
PASS/FAIL Criteria	<ul style="list-style-type: none"> <li>• Test procedure is fulfilled.</li> <li>• RCST does not leave fine sync state in step 8.</li> <li>• RCST transmits IP traffic in step 8.</li> </ul>	
Remarks	The test has to be performed with max. value for symbol_rate.	

Test Case not yet supported



Test Case ID	NCR_003_01	
Test Case Name	NCR Loss	
EN 301790 Reference	7.7.3	
Objective / Test Purpose	Verify that the RCST ceases transmission after loss of NCR for several consecutive seconds.	
Applicability / PICS	-	
Initial RCST State	Fine Sync state	
Expected Final RCST State	Off/Stand-by	
Test Method	Step	Description
	1	timer_value=(NCR_MAX_LOSS)
	2	Initiate IP traffic from Host PC at RCST side
	3	Hub issues the NCR with an update rate of 200 times/second
	4	Test system verifies RCST's transmit activities. Test system verifies that the RCST is transmitting in allocated timeslots.
	5	Preset timer with timer value
	6	Start timer
	7	Test system ceases transmission of NCR. Until the CTB supports this feature, the test engineer must disconnect the forward link from the device under test manually.
	8	Wait until timer has expired
	9	Test system verifies that the RCST does not transmit any bursts
PASS/FAIL Criteria	<ul style="list-style-type: none"> <li>• Test procedure is fulfilled.</li> <li>• RCST has achieved fine sync state in step 4.</li> <li>• RCST has set fine sync achieved flag in M&amp;C message of the SAC field in step 4.</li> <li>• RCST has ceased transmission 4 – 6 seconds after the NCR was lost.</li> </ul>	
Remarks	The test has to be performed with default value for symbol_rate.	

### 9.3 CSC Burst Transmission

This section verifies the correct formatting and transmission of CSC bursts from the terminal. By testing this it is ensured, that the terminal does not cause any negative impact to the satellite network, when it is accessing the common signaling channel.

#### Reason for having this test

The CSC is used as a common channel for all connected terminals. Only if the terminal accepts the information on the position of the CSC channel conflicts with other signals can be avoided. Furthermore, only if the formatting of the CSC burst which is generated in the terminal follows the specifications a logon to the network can be achieved.

**This section consists of 1 single test case:**

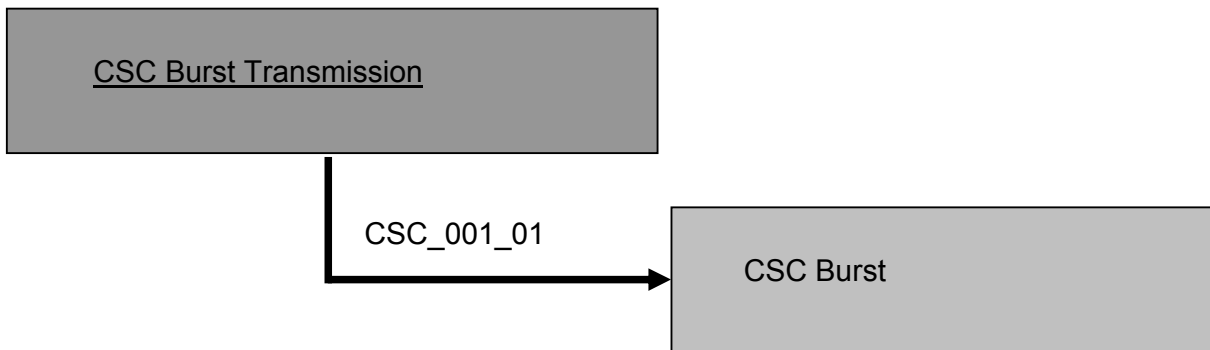

<b>Implementation of the Common Test House for DVB-RCS Terminals</b>	Doc. No: T3-061-v1	
<b>ESA Contract No: 16878/02/NL/US</b>	Version: 1.0	
	Date: 2005-11-13	

Test Case ID	CSC_001_01	
Test Case Name	CSC Burst	
EN 301790 Reference	6.2.3	
Objective / Test Purpose	Verify correct transmission and formatting and content of the CSC burst from the RCST being in Receive Sync state	
Applicability / PICS		
Initial RCST State	Receive sync state	
Expected Final RCST State	Receive sync state	
Test Method	Step	Description
	1	Initiate Logon procedure at RCST side
	2	RCST sends CSC burst
	3	Test system checks correct formatting and content of CSC burst (PIXIT item: RCST_CAP_FIELD and MAC_ADDR)
PASS/FAIL Criteria	<ul style="list-style-type: none"> <li>Correct CSC burst in step 3</li> </ul>	
Remarks		

<b>Implementation of the Common Test House for DVB-RCS Terminals</b>	Doc. No: T3-061-v1	
<b>ESA Contract No: 16878/02/NL/US</b>	Version: 1.0	
	Date: 2005-11-13	

#### **9.4 Logon Procedure**

This section verifies, that the terminal properly logs on the DVB-RCS network. Beside the reception of unicast TIMs it is checked, whether the terminal reacts in the expected way to unicast TIMs containing specific logon information. It is also checked whether a terminal ignores those unicast TIMs which are not addressed to the specific device under test.

#### **Reason for having this test**

Before any transmission can be done from the terminal to the network, it must be checked, if the connected user is part of the network. Only if the terminal is known and only if the network is capable of linking that terminal a transmission can be made up. To be able to check these two topics a logon procedure is required. This logon procedure allows the network to check authorisation as well as whether the HUB can be loaded by another terminal or not. Only if logon is handled properly by the RCST it can be ensured that the link can be made up. Assuming an RCST would not handle logon properly, there will be absolutely no chance to join the network. An important part of the logon handling as also the correct reaction, if logon is (temporarily) denied. In a situation where these reactions would not be as expected, a HUB/network could get overloaded by continuous logon requests.

This section consists of 9 single test cases:

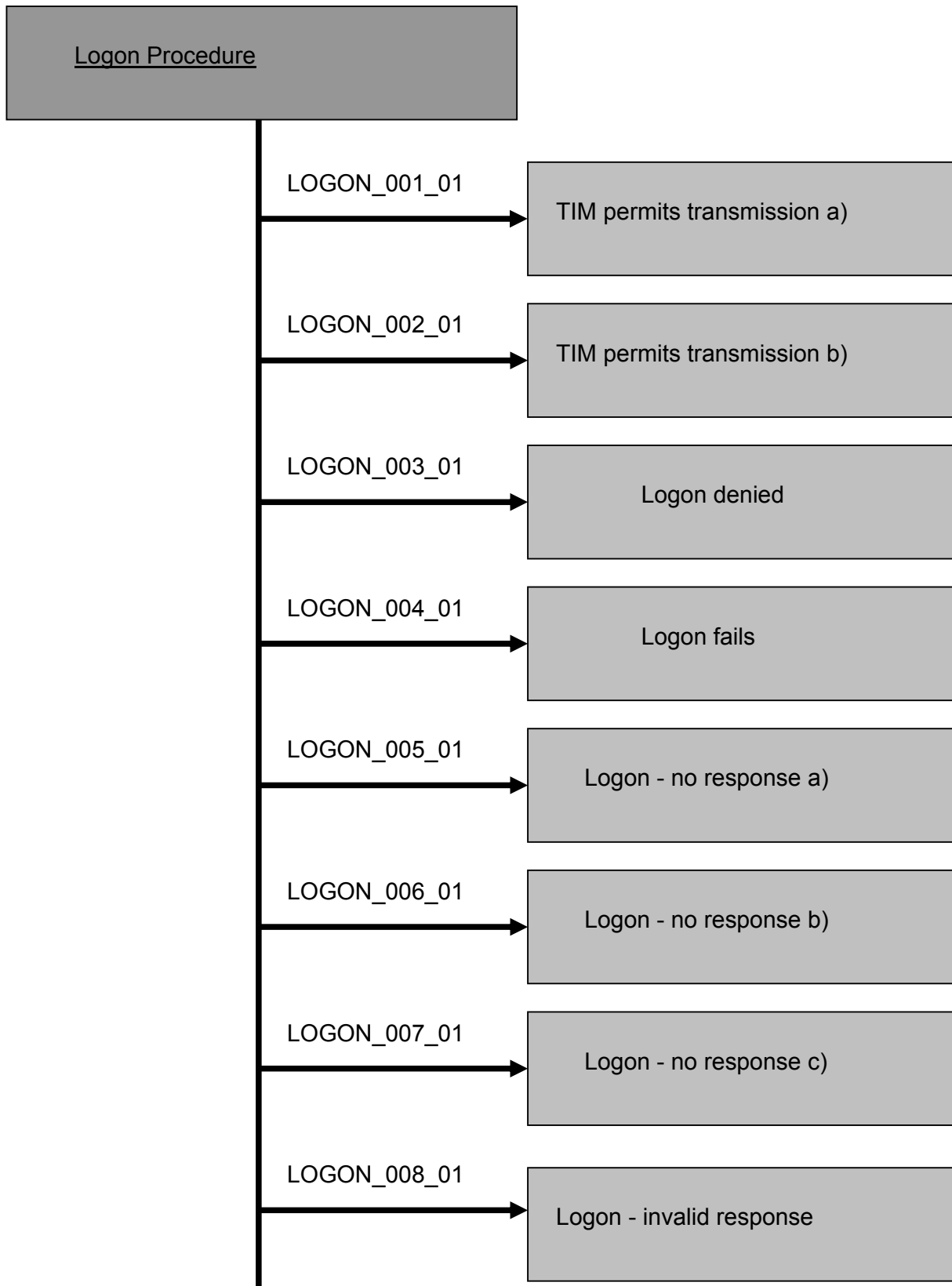

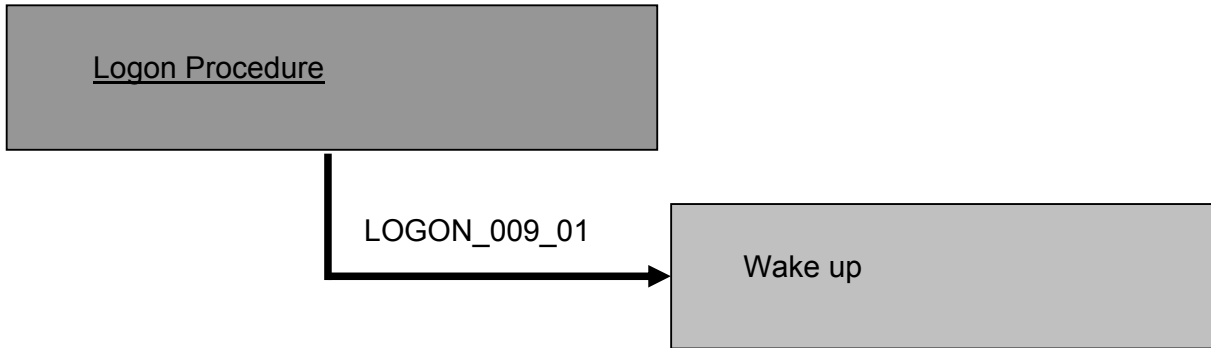

Test Case ID	LOGON_001_01	
Test Case Name	TIM permits transmission a)	
EN 301790 Reference	7.3	
Objective / Test Purpose	Verify that the RCST enters the "Ready for Coarse Sync" state on receipt of a unicast TIM permitting transmission	
Applicability / PICS	COARSE_SYNC	
Initial RCST State	Receive sync state	
Expected Final RCST State	Ready for Coarse Sync	
Test Method	Step	Description
	1	Initiate Logon procedure at RCST side
	2	RCST sends CSC burst
	3	Test system checks correct formatting and content of CSC burst
	4	Test system returns a unicast TIM (containing an ACQ_Assign_Descriptor) with time and frequency correction values < ACQ_Achieved threshold values (but greater than SYNC_Achieved_Time_Threshold)
	5	Test system verifies that the RCST transmits ACQ bursts
PASS/FAIL Criteria	<ul style="list-style-type: none"> <li>• Correct CSC burst in step 3</li> <li>• ACQ burst in step 5</li> </ul>	
Remarks	The values for "CSC_response_timeout" and "CSC_max_losses" are broadcast in the Contention Control descriptor (Broadcast TIM) The values for "ACQ_achieved_time_threshold" and "ACQ_achieved_frequency_threshold" are transmitted in the ACQ Assign descriptor of the unicast TIM	

<b>Implementation of the Common Test House for DVB-RCS Terminals</b>	Doc. No: T3-061-v1	
<b>ESA Contract No: 16878/02/NL/US</b>	Version: 1.0	
	Date: 2005-11-13	

Test Case ID	LOGON_002_01	
Test Case Name	TIM permits transmission b)	
EN 301790 Reference	7.3	
Objective / Test Purpose	Verify that the RCST enters the "Ready for Fine Sync" state on receipt of a unicast TIM permitting transmission	
Applicability / PICS	-	
Initial RCST State	Receive sync state	
Expected Final RCST State	Ready for Fine Sync	
Test Method	Step	Description
	1	Initiate Logon procedure at RCST side
	2	RCST sends CSC burst
	3	Test system verifies correct formatting and content of CSC burst
	4	Test system returns a unicast TIM (containing an ACQ_Assign_Descriptor) with time and frequency correction values < SYNC_Achieved threshold values
	5	Test system verifies that the RCST transmits SYNC bursts
PASS/FAIL Criteria	<ul style="list-style-type: none"> <li>• Correct CSC burst in step 3</li> <li>• SYNC burst in step 5</li> </ul>	
Remarks	<p>The values for "CSC_response_timeout" and "CSC_max_losses" are broadcast in the Contention Control descriptor (Broadcast TIM)</p> <p>The values for "SYNC_achieved_time_threshold" and "SYNC_achieved_frequency_threshold" are transmitted in the SYNC Assign descriptor of the unicast TIM</p>	



<b>Implementation of the Common Test House for DVB-RCS Terminals</b> <b>ESA Contract No: 16878/02/NL/US</b>	Doc. No: T3-061-v1 Version: 1.0 Date: 2005-11-13	
--	--	---

Test Case ID	LOGON_003_01	
Test Case Name	Logon denied	
EN 301790 Reference	7.3, 8.5.5.8	
Objective / Test Purpose	Verify that the RCST does not proceed with synchronization procedure upon receipt of a unicast TIM with information „Logon_denied“	
Applicability / PICS	-	
Initial RCST State	Receive sync state	
Expected Final RCST State	Receive sync state / Wait_in_standby_mode	
Test Method	Step	Description
	1	Initiate IP Logon procedure at RCST side
	2	RCST sends CSC burst
	3	Test system verifies correct formatting and content of CSC burst
	4	Test system returns a unicast TIM with information „Logon_denied“
	5	Test system verifies that the RCST transmits no CSC burst for the time as configured in the “wait in standby mode” timer
PASS/FAIL Criteria	<ul style="list-style-type: none"> <li>• Correct CSC burst in step 3</li> <li>• No CSC burst in step 5 in “wait_in_standby_mode”</li> </ul>	
Remarks	<p>The values for “CSC_response_timeout” and “CSC_max_losses” are broadcast in the Contention Control descriptor (Broadcast TIM)</p> <p>The manufacturer of the RCST is expected to provide the appropriate commands to configure the “wait in standby mode” timer.</p>	

Test Case ID	LOGON_004_01	
Test Case Name	Logon fails	
EN 301790 Reference	7.3, 8.5.5.8	
Objective / Test Purpose	Verify that the RCST does not proceed with synchronization procedure upon receipt of a unicast TIM with information „Logon_fail_(busy)“	
Applicability / PICS	-	
Initial RCST State	Receive sync state	
Expected Final RCST State	Receive sync state / Wait_in_standby_mode	
Test Method	Step	Description
	1	Initiate Logon procedure at RCST side
	2	RCST sends CSC burst
	3	Test system verifies correct formatting and content of CSC burst
	4	Test system returns a unicast TIM with information „Logon_fail_(busy)“
	5	Test system verifies that the RCST transmits no CSC burst for the time as configured in the “wait in standby mode” timer
PASS/FAIL Criteria	<ul style="list-style-type: none"> <li>• Correct CSC burst in step 3</li> <li>• No CSC burst in step 5 in “Wait_in_standby_mode”</li> </ul>	
Remarks	<p>The values for “CSC_response_timeout” and “CSC_max_losses” are broadcast in the Contention Control descriptor (Broadcast TIM)</p> <p>The manufacturer of the RCST is expected to provide the appropriate commands to configure the “wait in standby mode” timer.</p>	

<b>Implementation of the Common Test House for DVB-RCS Terminals</b>	Doc. No: T3-061-v1 Version: 1.0	
<b>ESA Contract No: 16878/02/NL/US</b>	Date: 2005-11-13	

Test Case ID	LOGON_005_01	
Test Case Name	Logon – no response a)	
EN 301790 Reference	7.3	
Objective / Test Purpose	Verify that the RCST retransmits the CSC burst if “CSC_response_timeout” has expired and no valid TIM has been received and “CSC_max_losses” has not exceeded.	
Applicability / PICS	-	
Initial RCST State	Receive sync state	
Expected Final RCST State	Receive sync state	
Test Method	Step	Description
	1	Initiate Logon procedure at RCST side
	2	RCST sends CSC burst
	3	Test system verifies correct formatting and content of CSC burst
	4	Wait for “CSC_response_timeout” No unicast TIM is returned
	5	Test system verifies that the RCST retransmits the CSC burst The retransmission of CSC bursts should be in the interval from 0 up to max_time_before_retry
PASS/FAIL Criteria	<ul style="list-style-type: none"> <li>• Correct CSC burst in step 3</li> <li>• CSC burst in step 5</li> </ul>	
Remarks	The values for “CSC_response_timeout” and “CSC_max_losses” are broadcast in the Contention Control descriptor (Broadcast TIM) max_time_before_retry also	

Test Case ID	LOGON_006_01	
Test Case Name	Logon – no response b)	
EN 301790 Reference	7.3	
Objective / Test Purpose	Verify that the RCST transmits no CSC burst if “CSC_response_timeout” has expired and no valid TIM has been received and “CSC_max_losses” has exceeded.	
Applicability / PICS	-	
Initial RCST State	Receive sync state	
Expected Final RCST State	Receive sync state	
Test Method	Step	Description
	1	Initiate Logon procedure at RCST side
	2	RCST sends CSC burst
	3	Check correct formatting and content of CSC burst with Return Link analyser
	4	Wait for “CSC_response_timeout” No unicast TIM is returned
	5	Repeat step 2 to 4 until “CSC_max_losses” has exceeded
	6	Test system verifies that the RCST transmits no CSC burst until n^2 max_time_before_retry has expired
PASS/FAIL Criteria	<ul style="list-style-type: none"> <li>• Correct CSC burst in step 3</li> <li>• No CSC burst in step 6</li> </ul>	
Remarks	The values for “CSC_response_timeout” and “CSC_max_losses” are broadcast in the Contention Control descriptor (Broadcast TIM)	

<b>Implementation of the Common Test House for DVB-RCS Terminals</b>	Doc. No: T3-061-v1 Version: 1.0	
<b>ESA Contract No: 16878/02/NL/US</b>	Date: 2005-11-13	

Test Case ID	LOGON_007_01	
Test Case Name	Logon – no response c)	
EN 301790 Reference	7.3	
Objective / Test Purpose	Verify that the RCST starts sending CSC bursts after timeout of “n <sup>2</sup> max_time_before_retry” (timeout after unsuccessful Logon procedure).	
Applicability / PICS	-	
Initial RCST State	Receive sync state	
Expected Final RCST State	Receive sync state	
Test Method	Step	Description
	1	Initiate Logon procedure at RCST side
	2	RCST sends CSC burst
	3	Test system verifies correct formatting and content of CSC burst
	4	Wait for “CSC_response_timeout” No unicast TIM is returned
	5	Repeat step 2 to 4 until “CSC_max_losses” has exceeded
	6	Test system verifies that the RCST transmits no CSC burst
	7	Wait for timeout of “n <sup>2</sup> max_time_before_retry”
	8	RCST sends CSC burst
PASS/FAIL Criteria	<ul style="list-style-type: none"> <li>• Correct CSC burst in step 3 and 9</li> <li>• No CSC burst in step 6</li> </ul>	
Remarks	The values for “CSC_response_timeout”, “CSC_max_losses” and “max_time_before_retry” are broadcast in the Contention Control descriptor (Broadcast TIM)	

<b>Implementation of the Common Test House for DVB-RCS Terminals</b>	Doc. No: T3-061-v1 Version: 1.0	
<b>ESA Contract No: 16878/02/NL/US</b>	Date: 2005-11-13	

Test Case ID	LOGON_008_01	
Test Case Name	Logon – invalid response	
EN 301790 Reference	7.3, 8.2	
Objective / Test Purpose	Verify that the RCST remains in the Logon procedure (sending of CSC bursts) when receiving a unicast TIM message containing a MAC address different from its own MAC address.	
Applicability / PICS	-	
Initial RCST State	Receive sync state	
Expected Final RCST State	Receive sync state	
Test Method	Step	Description
	1	Initiate Logon procedure at RCST side
	2	RCST sends CSC bursts
	3	Test system returns a unicast TIM containing a MAC address different from the RCST's address
	4	Wait for "CSC_response_timeout"
	5	Test system verifies that the RCST retransmits the CSC burst
PASS/FAIL Criteria	<ul style="list-style-type: none"> <li>• Correct CSC burst in step 3</li> <li>• CSC burst in step 5</li> </ul>	
Remarks	The values for "CSC_response_timeout" and "CSC_max_losses" are broadcast in the Contention Control descriptor (Broadcast TIM)	

<b>Implementation of the Common Test House for DVB-RCS Terminals</b> <b>ESA Contract No: 16878/02/NL/US</b>	Doc. No: T3-061-v1 Version: 1.0 Date: 2005-11-13	
--	--	---

Test Case ID	LOGON_009_01	
Test Case Name	Wake up	
EN 301790 Reference	7.3, 8.5.5.8	
Objective / Test Purpose	To show that the RCST when in "Receive sync" state and receiving a TIM message containing information "wake_up" initiates Logon procedure.	
Applicability / PICS	-	
Initial RCST State	Receive sync state	
Expected Final RCST State	Ready for fine sync state	
Test Method	Step	Description
	1	Test System transmits SI Tables and TIM-B
	2	RCST acquires forward link but is forced not to log on
	3	Test System waits for 60 second checking that no CSC burst is received.
	4	Test System sends Unicast-TIM containing the RCST status "wake-up"
	5	RCST sends CSC burst to acquire the return link
	6	Test system verifies correct formatting and content of CSC burst
	7	Test system returns a unicast TIM permitting logon
	8	Test system verifies that the RCST transmits (ACQ optional) SYNC bursts
PASS/FAIL Criteria	<ul style="list-style-type: none"> <li>• Correct CSC burst in step 5</li> <li>• SYNC bursts in step 8</li> </ul>	
Remarks	Manufacturer of the RCST is expected to provide the procedure to let the RCST acquire the Forward Link but to keep it from automatically acquiring the Return Link.	

<b>Implementation of the Common Test House for DVB-RCS Terminals</b>	Doc. No: T3-061-v1	
<b>ESA Contract No: 16878/02/NL/US</b>	Version: 1.0	
	Date: 2005-11-13	

## 9.5 Coarse Synchronization Procedure

This section verifies that the Coarse Synchronization Procedure is implemented properly. The terminal is forced into all defined stages of the float chart which is specified in EN 301 790.

### Reason for having this test

In networks which are using shared media, there are initially two options to organise traffic from multiple sources. While LAN techniques use tokens or collision detection, satellite networks need to use another method. As the latency of the transmission path is high a potential collision can not be detected, all terminals need to be synchronised. Synchronisation itself can be implemented in different ways. The most robust one is an iterative method where the terminal passes several stages until reaching synchronization maintenance. If synchronisation would not be achieved and maintained, no terminal would know when to transmit its data packets without taking the risk of overlapping with others. The HUB, furthermore, need to be sure, that it only receives packets from one terminal in a specific time-slot. As this section addresses one of the single stages in the synchronisation process it is essential to have this test.

Note: The correction values in the CMT and Correction Message Descriptor during Coarse Synchronisation, Fine Synchronisation and Synchronisation Maintenance procedure are for:

- Timing correction
- Frequency correction

The RCST shall be able to react accordingly.



This section consists of 5 single test cases:

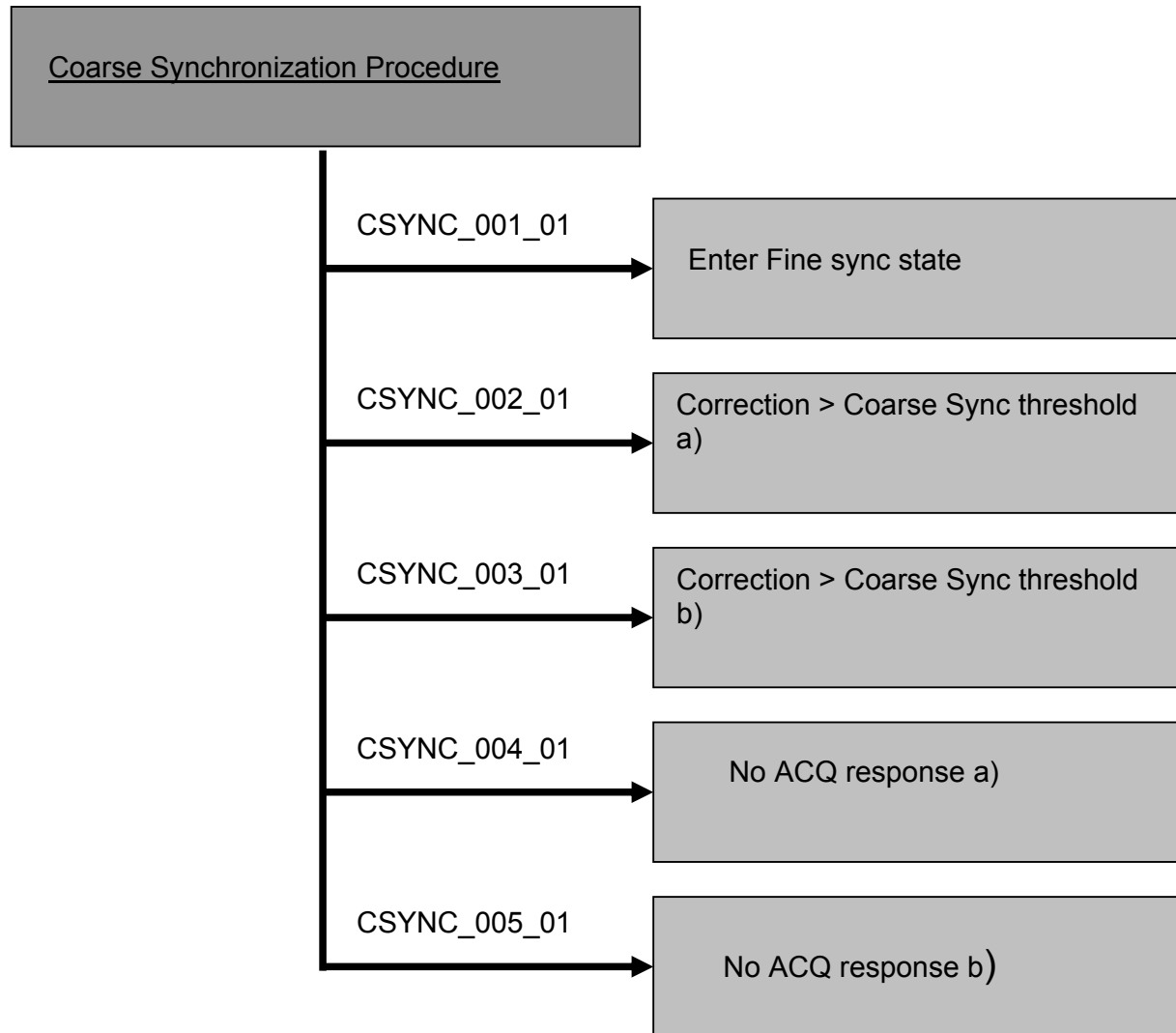

<b>Implementation of the Common Test House for DVB-RCS Terminals</b>	Doc. No: T3-061-v1 Version: 1.0	
<b>ESA Contract No: 16878/02/NL/US</b>	Date: 2005-11-13	

Test Case ID	CSYNC_001_01	
Test Case Name	Enter Fine sync state	
EN 301790 Reference	7.4	
Objective / Test Purpose	Verify that the RCST enters the "Ready for Fine sync" state on receipt of a CMT „correction < Coarse Sync threshold“.	
Applicability / PICS	COARSE_SYNC	
Initial RCST State	Ready for Coarse Sync	
Expected Final RCST State	Ready for Fine Sync	
Test Method	Step	Description
	1	RCST is in "ready for coarse sync" state and is sending ACQ bursts
	2	Test system returns a CMT with time and frequency correction values < ACQ_Achieved threshold values
	3	Test system verifies that the RCST stops sending ACQ bursts and transmits SYNC bursts
	4	Test System verifies that the bursts transmitted by the RCST remain in the expected burst limits (SYNC_Achieved_thresholds).
	5	Verify that the correction values that are observed by the test system are smaller than the SYNC_Achieved_thresholds.
PASS/FAIL Criteria	<ul style="list-style-type: none"> <li>• SYNC bursts in step 3</li> <li>• Expected time and frequency position of the bursts (within thresholds) in step 5</li> </ul>	
Remarks	The values for "SYNC_achieved_time_threshold" and "SYNC_achieved_frequency_threshold" are transmitted in the SYNC Assign descriptor of the unicast TIM	

Test Case ID	CSYNC_002_01	
Test Case Name	Correction > Coarse Sync threshold a)	
EN 301790 Reference	7.4	
Objective / Test Purpose	Verify that the RCST retransmits the ACQ burst on receipt of a CMT „correction > Coarse Sync threshold“ and “max tries” has not exceeded.	
Applicability / PICS	COARSE_SYNC	
Initial RCST State	Ready for Coarse Sync	
Expected Final RCST State	Ready for Coarse Sync	
Test Method	Step	Description
	1	Initiate Logon procedure at RCST side
	2	RCST sends CSC burst
	3	Test system returns a unicast TIM with time and frequency correction values > ACQ_Achieved threshold values
	4	Test system verifies that the RCST transmits an ACQ burst
	5	Test system verifies that the ACQ burst received is within the expected burst window (within the ACQ_Achieved thresholds)
	6	Test system returns a CMT with time and frequency correction values > coarse sync threshold values
	7	Test System verifies that the RCST keeps on sending ACQ bursts.
	8	Test System verifies that the RCST corrects the burst timing and frequency in way that it falls into the expected burst window (within the ACQ_Achieved thresholds)
	9	Repeat step 6 to step 8 as long as “max_tries” has not exceeded
PASS/FAIL Criteria	<ul style="list-style-type: none"> <li>• ACQ burst in step 4 and 7</li> <li>• Burst reception within the ACQ_Achieved threshold in step 5 and 8.</li> </ul>	
Remarks	The values for “ACQ_achieved_time_threshold” and “ACQ_achieved_frequency_threshold” are transmitted in the ACQ Assign descriptor of the unicast TIM	

Test Case ID	CSYNC_003_01	
Test Case Name	Correction > Coarse Sync threshold b)	
EN 301790 Reference	7.4	
Objective / Test Purpose	Verify that the RCST enters the "Off /Stand-by" state on receipt of a CMT „correction > Coarse Sync threshold“ and "max tries" has exceeded.	
Applicability / PICS	COARSE_SYNC	
Initial RCST State	Ready for Coarse Sync	
Expected Final RCST State	Wait_in_standby_mode	
Test Method	Step	Description
	1	Initiate Logon procedure at RCST side
	2	RCST sends CSC burst
	3	Test system returns a unicast TIM with time and frequency correction values > ACQ_Achieved threshold values
	4	Test system verifies that the RCST transmits an ACQ burst
	5	Test system verifies that the ACQ burst received is within the expected burst window (within the ACQ_Achieved thresholds)
	6	Test system returns a CMT with time and frequency correction values > ACQ_Achieved threshold values
	7	Test System verifies that the RCST keeps on sending ACQ bursts.
	8	Test System verifies that the RCST corrects the burst timing and frequency in way that it falls into the expected burst window (within the ACQ_Achieved thresholds)
	9	Repeat step 6 to step 8 until "max_tries" has been exceeded
	10	Verify with Return Link analyser that the RCST transmits no bursts within the cofigured "wait in standby mode" timer.
PASS/FAIL Criteria	<ul style="list-style-type: none"> <li>• ACQ burst in step 4 an 7</li> <li>• Burst reception within the ACQ_Achieved threshold in step 5 and 8.</li> <li>• No ACQ burst in step 9 in "Wait_in_standby_mode"</li> </ul>	
Remarks	<p>The values for "ACQ_achieved_time_threshold", "ACQ_achieved_frequency_threshold" and "ACQ_repeats" are transmitted in the ACQ Assign descriptor of the unicast TIM</p> <p>The manufacturer of the RCST is expected to provide the appropriate commands to configure the "wait in standby mode" timer.</p>	

Test Case ID	CSYNC_004_01	
Test Case Name	No ACQ response a)	
EN 301790 Reference	7.4	
Objective / Test Purpose	Verify that the RCST retransmits the ACQ burst if “ACQ_response_timeout” has expired and no CMT has been received and “ACQ_max_losses” has not been exceeded	
Applicability / PICS	COARSE_SYNC	
Initial RCST State	Ready for Coarse Sync	
Expected Final RCST State	Ready for Coarse Sync	
Test Method	Step	Description
	1	Initiate Logon procedure at RCST side
	2	RCST sends CSC burst
	3	Test system returns a unicast TIM with time and frequency correction values > ACQ_Achieved threshold values
	4	Test system verifies that the RCST transmits an ACQ burst
	5	Test system verifies that the ACQ burst received is within the expected burst window (within the ACQ_Achieved thresholds)
	6	Wait for “ACQ_response_timeout” No CMT is returned by the test system
	7	Test system verifies that the RCST retransmits ACQ bursts
	8	Repeat step 5 to step 7 as long as ACQ_max_losses has not exceeded
PASS/FAIL Criteria	<ul style="list-style-type: none"> <li>• ACQ bursts in step 4 and 7</li> <li>• Burst reception within the ACQ_Achieved threshold in step 5.</li> </ul>	
Remarks	The values for “ACQ_achieved_time_threshold”, “ACQ_achieved_frequency_threshold” and “ACQ_repeats” are transmitted in the ACQ Assign descriptor of the unicast TIM “ACQ_response_timeout” and “ACQ_max_losses” are distributed in Correction Control descriptor.	

Test Case ID	CSYNC_005_01	
Test Case Name	No ACQ response b)	
EN 301790 Reference	7.4	
Objective / Test Purpose	Verify that the RCST enters the "Off /Stand-by" state if "ACQ_response_timeout" has expired and no CMT has been received and "ACQ_max_losses" has been exceeded	
Applicability / PICS	COARSE_SYNC	
Initial RCST State	Ready for Coarse Sync	
Expected Final RCST State	Wait_in_standby_mode	
Test Method	Step	Description
	1	Initiate Logon procedure at RCST side
	2	RCST sends CSC burst
	3	Test system returns a unicast TIM with time and frequency correction values > ACQ_Achieved threshold values
	4	Test system verifies that the RCST transmits an ACQ burst
	5	Test system verifies that the ACQ burst received is within the expected burst window (within the ACQ_Achieved thresholds)
	6	Wait for "ACQ_response_timeout" No CMT is returned by the test system
	7	Test system verifies that the RCST retransmits ACQ bursts
	8	Repeat step 5 to step 7 until ACQ_max_losses has been exceeded
	10	Test system verifies that the RCST transmits no bursts during the configured "wait in standby mode" timer.
PASS/FAIL Criteria	<ul style="list-style-type: none"> <li>• ACQ bursts in step 4 and 7</li> <li>• No ACQ burst in step 10 in "Wait_in_standby_mode"</li> <li>• Correct time and frequency correction in step 6</li> <li>• Bursts received within the ACQ_Achieved threshold in step 5.</li> </ul>	
Remarks	<p>The values for "ACQ_achieved_time_threshold", "ACQ_achieved_frequency_threshold" and "ACQ_repeats" are transmitted in the ACQ Assign descriptor of the unicast TIM</p> <p>"ACQ_response_timeout" and "ACQ_max_losses" are distributed in Correction Control descriptor.</p> <p>The manufacturer of the RCST is expected to provide the appropriate commands to configure the "wait in standby mode" timer.</p>	

<b>Implementation of the Common Test House for DVB-RCS Terminals</b>	Doc. No: T3-061-v1	
<b>ESA Contract No: 16878/02/NL/US</b>	Version: 1.0	
	Date: 2005-11-13	

## 9.6 Fine Synchronization Procedure

This section verifies that the Fine Synchronization Procedure is implemented properly. The terminal is forced into all defined stages of the float chart which is specified in EN 301 790.

### Reason for having this test

In networks which are using shared media, there are initially two options to organise traffic from multiple sources. While LAN techniques use tokens or collision detection, satellite networks need to use another method. As the latency of the transmission path is high a potential collision can not be detected, all terminals need to be synchronised. Synchronisation itself can be implemented in different ways. The most robust one is an iterative method where the terminal passes several stages until reaching synchronization maintenance. If synchronisation would not be achieved and maintained, no terminal would know when to transmit its data packets without taking the risk of overlapping with others. The HUB, furthermore, need to be sure, that it only receives packets from one terminal in a specific time-slot. As this section addresses one of the single stages in the synchronisation process it is essential to have this test.

This section consists of 5 single test cases.

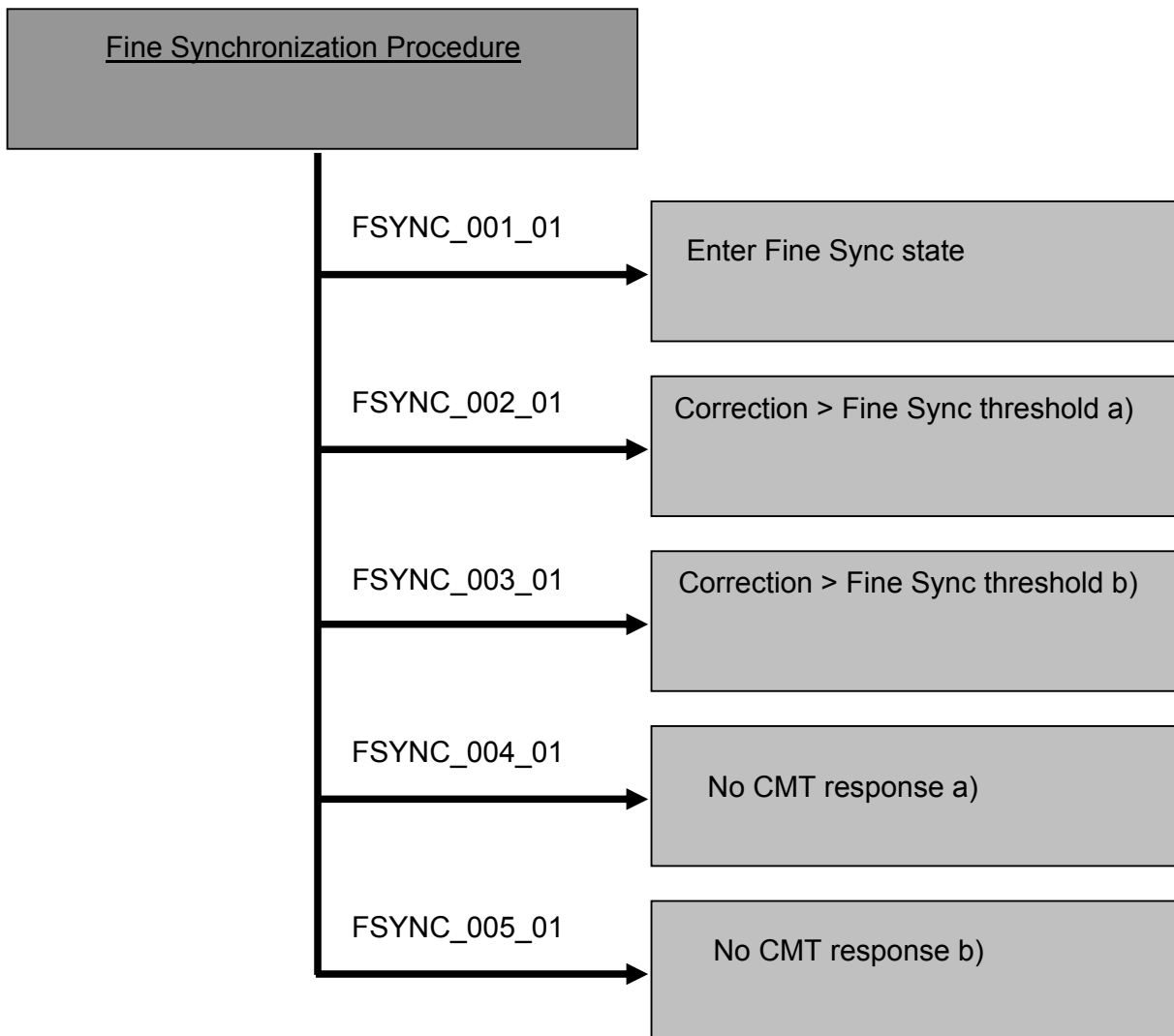





<b>Implementation of the Common Test House for DVB-RCS Terminals</b>	Doc. No: T3-061-v1	
<b>ESA Contract No: 16878/02/NL/US</b>	Version: 1.0	
	Date: 2005-11-13	

Test Case ID	FSYNC_001_01	
Test Case Name	Enter Fine Sync state	
EN 301790 Reference	7.5	
Objective / Test Purpose	Verify that the RCST enters the Fine Sync state and sets the Fine Sync flag to 1 on receipt of a CMT „correction < Fine Sync threshold“.	
Applicability / PICS		
Initial RCST State	Ready for Fine Sync	
Expected Final RCST State	Fine Sync state	
Test Method	Step	Description
	1	Test system returns a CMT with time and frequency correction values > SYNC_Achieved threshold values
	2	RCST re-transmits a SYNC bursts with corrected burst frequency and timing
	3	Test system returns a CMT with time and frequency correction values < SYNC_Achieved threshold values
	4	Test system verifies that the RCST transmits a SYNC burst containing a SAC field with the Fine_Sync_Achieved_flag set to 1
	5	Test system verifies that the SYNC burst received is within the expected burst window (within the SYNC_Achieved thresholds)
PASS/FAIL Criteria	<ul style="list-style-type: none"> <li>• SYNC burst with SAC field having Fine_Sync_Achieved_Flag set to 1 in step 4</li> <li>• Bursts received within the ACQ_Achieved threshold in step 5.</li> </ul>	
Remarks	The values for “SYNC_achieved_time_threshold” and “SYNC_achieved_frequency_threshold” are transmitted in the SYNC Assign descriptor of the unicast TIM	

Test Case ID	FSYNC_002_01	
Test Case Name	Correction > Fine Sync threshold a)	
EN 301790 Reference	7.5	
Objective / Test Purpose	Verify that the RCST retransmits SYNC bursts with the Fine Sync flag set to 0 on receipt of a CMT with "correction > Fine Sync threshold" and "max_tries" has not exceeded.	
Applicability / PICS		
Initial RCST State	Ready for Fine Sync	
Expected Final RCST State	Ready for Fine Sync	
Test Method	Step	Description
	1	RCST sends SYNC burst
	2	Test system returns a CMT with time and frequency correction values > SYNC_Achieved threshold values
	3	Test system verifies that the RCST re-transmits the SYNC burst containing a SAC field with the Fine_Sync_Achieved_Fleg sat to zero
	4	Test system verifies that the SYNC burst received is within the expected burst window (within the SYNC_Achieved thresholds)
	5	Test system returns a CMT with time and frequency correction values > SYNC_Achieved threshold values
	6	Test System verifies that the RCST keeps on sending SYNC bursts containing a SAC field with the Fine_Sync_Achieved_Flag set to zero.
	7	Test System verifies that the RCST corrects the burst timing and frequency in way that it falls into the expected burst window (within the SYNC_Achieved thresholds)
PASS/FAIL Criteria	<ul style="list-style-type: none"> <li>• SYNC burst with Fine Sync flag set to 0 in step 3 and 6.</li> <li>• Bursts received within the ACQ_Achieved threshold in step 4 and 7.</li> </ul>	
Remarks	The values for "SYNC_achieved_time_threshold" and "SYNC_achieved_frequency_threshold" are transmitted in the SYNC Assign descriptor of the unicast TIM	

<b>Implementation of the Common Test House for DVB-RCS Terminals</b>	Doc. No: T3-061-v1	
<b>ESA Contract No: 16878/02/NL/US</b>	Version: 1.0	
	Date: 2005-11-13	

Test Case ID	FSYNC_003_01	
Test Case Name	Correction > Fine Sync threshold b)	
EN 301790 Reference	7.5	
Objective / Test Purpose	Verify that the RCST enters the Off / Stand-by state on receipt of a CMT with "correction > Fine Sync threshold" and "max_tries" has exceeded.	
Applicability / PICS		
Initial RCST State	Ready for Fine Sync	
Expected Final RCST State	Wait_in_standby_mode	
Test Method	Step	Description
	1	RCST sends SYNC burst
	2	Test system returns a CMT with time and frequency correction values > SYNC_Achieved threshold values
	3	Test system verifies that the RCST re-transmits the SYNC burst containing a SAC field with the Fine_SYNC_Achieved_Flag set to zero.
	4	Test system verifies that the SYNC burst received is within the expected burst window (within the SYNC_Achieved thresholds)
	5	Test system returns a CMT with time and frequency correction values > SYNC_Achieved threshold values
	6	Test System verifies that the RCST keeps on sending SYNC bursts containing a SAC field with the Fine_Sync_Achieved_Flag set to zero.
	7	Test System verifies that the RCST corrects the burst timing and frequency in way that it falls into the expected burst window (within the SYNC_Achieved thresholds)
	8	Repeat step 5 to 7 until "max_tries" has been exceeded
9	Test system verifies that no bursts are sent by the RCST during the configured "wait in standby mode" timer.	
PASS/FAIL Criteria	<ul style="list-style-type: none"> <li>• SYNC burst with Fine Sync flag set to 0 in step 3 and 6</li> <li>• Bursts received within the ACQ_Achieved threshold in step 4 and 7.</li> <li>• No burst in step 6 in "Wait_in_standby_mode"</li> </ul>	
Remarks	<p>The values for "SYNC_achieved_time_threshold", "SYNC_achieved_frequency_threshold" and "max_tries" are transmitted in the SYNC Assign descriptor of the unicast TIM</p> <p>The manufacturer of the RCST is expected to provide the appropriate commands to configure the "wait in standby mode" timer.</p>	

<b>Implementation of the Common Test House for DVB-RCS Terminals</b>	Doc. No: T3-061-v1	
<b>ESA Contract No: 16878/02/NL/US</b>	Version: 1.0	
	Date: 2005-11-13	

Test Case ID	FSYNC_004_01	
Test Case Name	No CMT response a)	
EN 301790 Reference	7.5	
Objective / Test Purpose	Verify that the RCST retransmits the SYNC burst if “SYNC_response_timeout” has expired and no CMT has been received and “SYNC_max_losses” has not been exceeded.	
Applicability / PICS		
Initial RCST State	Ready for Fine Sync	
Expected Final RCST State	Ready for Fine Sync	
Test Method	Step	Description
	1	RCST transmits SYNC burst
	2	Wait for “SYNC_response_timeout” No CMT is returned by the test system
	3	Test system verifies that the RCST re-transmits the SYNC burst
	4	Repeat step 1 to step 3 as long as “SYNC_max_losses” has not been exceeded
PASS/FAIL Criteria	<ul style="list-style-type: none"> <li>• SYNC burst in step 3</li> </ul>	
Remarks	The values for “SYNC_response_timeout” and “SYNC_max_losses” are broadcast in the Correction Control descriptor (Broadcast TIM)	

<b>Implementation of the Common Test House for DVB-RCS Terminals</b> <b>ESA Contract No: 16878/02/NL/US</b>	Doc. No: T3-061-v1 Version: 1.0 Date: 2005-11-13	
--	--	---

Test Case ID	FSYNC_005_01	
Test Case Name	No CMT response b)	
EN 301790 Reference	7.5	
Objective / Test Purpose	Verify that the RCST enters the "Off /Stand-by" state if "SYNC_response_timeout" has expired and no CMT has been received and "SYNC_max_losses" has been exceeded.	
Applicability / PICS		
Initial RCST State	Ready for Fine Sync	
Expected Final RCST State	Wait_in_standby_mode	
Test Method	Step	Description
	1	RCST transmits SYNC burst
	2	Wait for "SYNC_response_timeout" No CMT is returned by the test system
	3	Test system verifies that the RCST retransmits the SYNC burst
	4	Repeat step 1 to 3 until "SYNC_max_losses" has been exceeded
	5	Test system verifies that the RCST transmits no burst during the configured "wait in standby mode" timer
PASS/FAIL Criteria	<ul style="list-style-type: none"> <li>• SYNC burst in step 3</li> <li>• No burst in step 5 in "Wait_in_standby_mode"</li> </ul>	
Remarks	<p>The values for "SYNC_response_timeout" and "SYNC_max_losses" are broadcast in the Correction Control descriptor (Broadcast TIM)</p> <p>The manufacturer of the RCST is expected to provide the appropriate commands to configure the "wait in standby mode" timer.</p>	

<b>Implementation of the Common Test House for DVB-RCS Terminals</b>	Doc. No: T3-061-v1	
<b>ESA Contract No: 16878/02/NL/US</b>	Version: 1.0	
	Date: 2005-11-13	

### **7.7 Synchronization Maintenance Procedure**

This section verifies, that the terminal maintains synchronisation after achieving sync state. The terminal is forced into all defined stages of the float chart which is specified in EN 301 790.

#### **Reason for having this test**

In networks which are using shared media, there are initially two options to organise traffic from multiple sources. While LAN techniques use tokens or collision detection, satellite networks need to use another method. As the latency of the transmission path is high a potential collision can not be detected, all terminals need to be synchronised. Synchronisation itself can be implemented in different ways. The most robust one is an iterative method where the terminal passes several stages until reaching synchronization maintenance. If synchronisation would not be achieved and maintained, no terminal would know when to transmit its data packets without taking the risk of overlapping with others. The HUB, furthermore, need to be sure, that it only receives packets from one terminal in a specific time-slot. As this section addresses the most important part of the synchronisation processes – the synchronisation maintenance – it is essential to have this test. When in synchronisation maintenance the terminal needs to continuously check the sync state. As soon as there is the case of non-sync the transmission must be ceased to prevent any harm to the network.

This section consists of 4 single test cases:

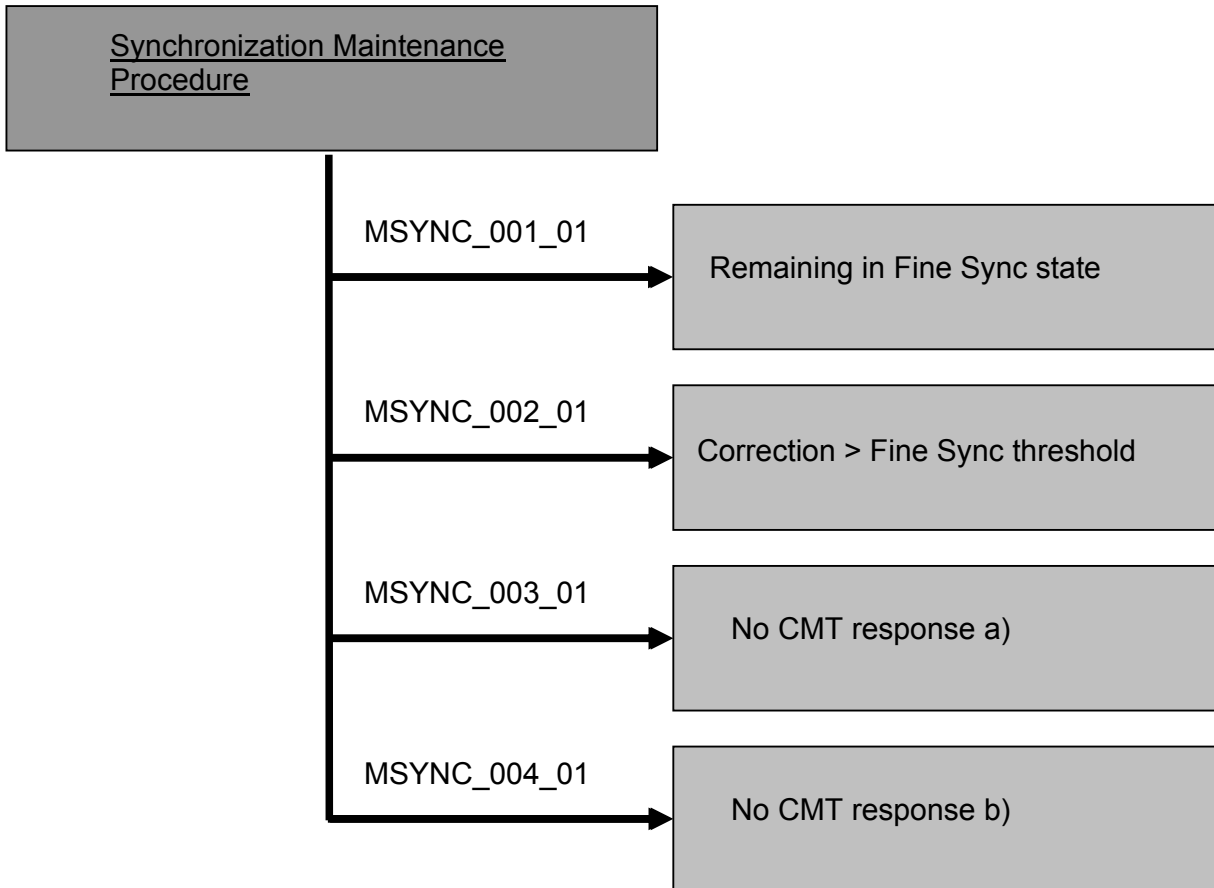

Test Case ID	MSYNC_001_01	
Test Case Name	Remaining in Fine Sync state	
EN 301790 Reference	7.6	
Objective / Test Purpose	Verify that the RCST remains in the Fine Sync state and sets the Fine Sync flag to 1 on receipt of a CMT „correction < Fine Sync threshold“.	
Applicability / PICS		
Initial RCST State	Fine Sync state	
Expected Final RCST State	Fine Sync state	
Test Method	Step	Description
	1	Test system returns a CMT with time and frequency correction values < Fine sync threshold values
	2	Test system verifies that the RCST transmits a SYNC burst with Fine Sync flag set to 1
	3	Test system verifies that the SYNC burst received is within the expected burst window (within the SYNC_Achieved thresholds)
	4	Test system returns a CMT with time and frequency correction values < Fine sync threshold values
	5	Test system verifies that the RCST keeps on sending SYNC bursts
	6	Test system verifies that the SYNC burst received is within the expected burst window (within the SYNC_Achieved thresholds)
	7	Repeat step 4 to 6 for 3 minutes
PASS/FAIL Criteria	<ul style="list-style-type: none"> <li>• SYNC burst with Fine Sync flag set to 1 in step 2</li> <li>• Bursts received within the SYNC_Achieved threshold in step 3 and 6.</li> </ul>	
Remarks	The values for “SYNC_achieved_time_threshold” and “SYNC_achieved_frequency_threshold” are transmitted in the SYNC Assign descriptor of the unicast TIM	



Test Case ID	MSYNC_002_01	
Test Case Name	Correction > Fine Sync threshold	
EN 301790 Reference	7.6	
Objective / Test Purpose	Verify that the RCST enters the Off / Stand-by state on receipt of a CMT „correction > Fine Sync threshold“.	
Applicability / PICS		
Initial RCST State	Fine Sync state	
Expected Final RCST State	Wait_in_standby_mode	
Test Method	Step	Description
	1	Test system returns a CMT with time and frequency correction values > Fine sync threshold values
	2	Test system verifies that the RCST transmits no burst within the configured “wait in standby mode” timer
PASS/FAIL Criteria	<ul style="list-style-type: none"> <li>No burst in step 2 in “Wait_in_standby_mode”</li> </ul>	
Remarks	<p>The values for “SYNC_achieved_time_threshold” and “SYNC_achieved_frequency_threshold” are transmitted in the SYNC Assign descriptor of the unicast TIM</p> <p>The manufacturer of the RCST is expected to provide the appropriate commands to configure the “wait in standby mode” timer.</p>	

<b>Implementation of the Common Test House for DVB-RCS Terminals</b>	Doc. No: T3-061-v1 Version: 1.0	
<b>ESA Contract No: 16878/02/NL/US</b>	Date: 2005-11-13	

Test Case ID	MSYNC_003_01	
Test Case Name	No CMT response a)	
EN 301790 Reference	7.6	
Objective / Test Purpose	Verify that the RCST remains in the Fine Sync state and retransmits the SYNC burst if "SYNC_response_timeout" has expired and no CMT has been received and "SYNC_max_losses" has not been exceeded.	
Applicability / PICS		
Initial RCST State	Fine Sync state	
Expected Final RCST State	Fine Sync state	
Test Method	Step	Description
	1	RCST transmits SYNC burst
	2	Wait for "SYNC_response_timeout" No CMT is returned by the test system
	3	Test system verifies that the RCST retransmits the SYNC burst
	4	Repeat step 1 to step 3 as long as "SYNC_max_losses" has not been exceeded
PASS/FAIL Criteria	<ul style="list-style-type: none"> <li>No burst in step 2</li> </ul>	
Remarks	The values for "SYNC_response_timeout" and "SYNC_max_losses" are broadcast in the Correction Control descriptor (Broadcast TIM)	

Test Case ID	MSYNC_004_01	
Test Case Name	No CMT response b)	
EN 301790 Reference	7.6	
Objective / Test Purpose	Verify that the RCST enters the "Off /Stand-by" state if "SYNC_response_timeout" has expired and no CMT has been received and "SYNC_max_losses" has been exceeded.	
Applicability / PICS		
Initial RCST State	Fine Sync state	
Expected Final RCST State	Wait_in_standby_mode	
Test Method	Step	Description
	1	RCST transmits SYNC burst
	2	Wait for "SYNC_response_timeout" No CMT is returned by the test system
	3	Test system verifies that the RCST retransmits the SYNC burst
	4	Repeat step 1 to 3 until "SYNC_max_losses" has been exceeded
	5	Test system verifies that the RCST transmits no burst during the configured "wait in standby mode" timer
PASS/FAIL Criteria	<ul style="list-style-type: none"> <li>• SYNC burst in step 3</li> <li>• No burst in step 5 in "Wait_in_standby_mode"</li> </ul>	
Remarks	<p>The values for "SYNC_response_timeout" and "SYNC_max_losses" are broadcast in the Correction Control descriptor (Broadcast TIM)</p> <p>The manufacturer of the RCST is expected to provide the appropriate commands to configure the "wait in standby mode" timer.</p>	

## 9.8 Forward Link Reception

This section verifies, that a UDP connection can be set up properly via the DVB-RCS terminal.

### Reason for having this test

Data transmission is the real goal of any satellite interactive link. Before any application is brought onto a link, it must be clear that communication is possible. Checking the transmission link using a UDP connection also opens the opportunity to assess the error freeness of the transmission link.

**This section consists of 1 single test case:**

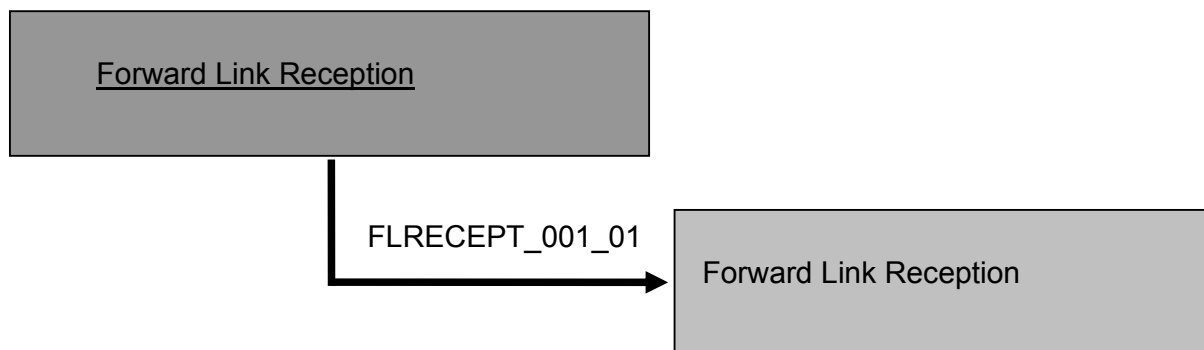

Test Case ID	FLRECEPT_001_01	
Test Case Name	Forward Link Reception	
EN 301790 Reference		
Objective / Test Purpose	Verify quasi error-free UDP packet reception over the Forward Link.	
Applicability / PICS		
Initial RCST State	Fine Sync state	
Expected Final RCST State	Fine Sync state	
Test Method	Step	Description
	1	Test system transmits via the Forward Link $1 \cdot 10^3$ UDP packets with 1500 bytes packet size at 512kbps
	2	Test system verifies that the RCST forwards all packets via its Ethernet interface and all packets are received
PASS/FAIL Criteria	<ul style="list-style-type: none"> <li>Error-free UDP packets in step 2; Usual error occurrences as they must be expected in usual UDP transmission shall not be deemed as fail criteria for the terminal.</li> </ul>	
Remarks		

### 9.9 Return Link Traffic Transmission & Capacity Requesting

The return link uses a shared medium for several terminals. Therefore a capacity handling is vital for DVB-RCS networks. This section verifies, that a terminal is capable of transmitting error-free UDP traffic by using various capacity request schemes. All schemes which are specified in EN 301 790 are considered in this section.

#### Reason for having this test

Capacity in satellite interactive networks – especially in the return channel – is rare. However, to appropriately serve applications a certain data upstream must be guaranteed. To allocate a certain constant capacity is an easy but expensive way to do. Other methods – primarily flexible ones – need to be addressed. DVB-RCS describes several methods of dynamic capacity requests. Only if these methods do follow the determined rules and syntax the overall capacity can be shared between the terminals without collapsing. If a capacity request would not work properly, a terminal would not get a burst allocation to send out its data. The data buffer will overflow and a service provision is impossible. Furthermore, if a terminal requests more bursts than required, capacity is booked for others which would force problems with the overall performance.

**This section consists of 4 single test cases:**

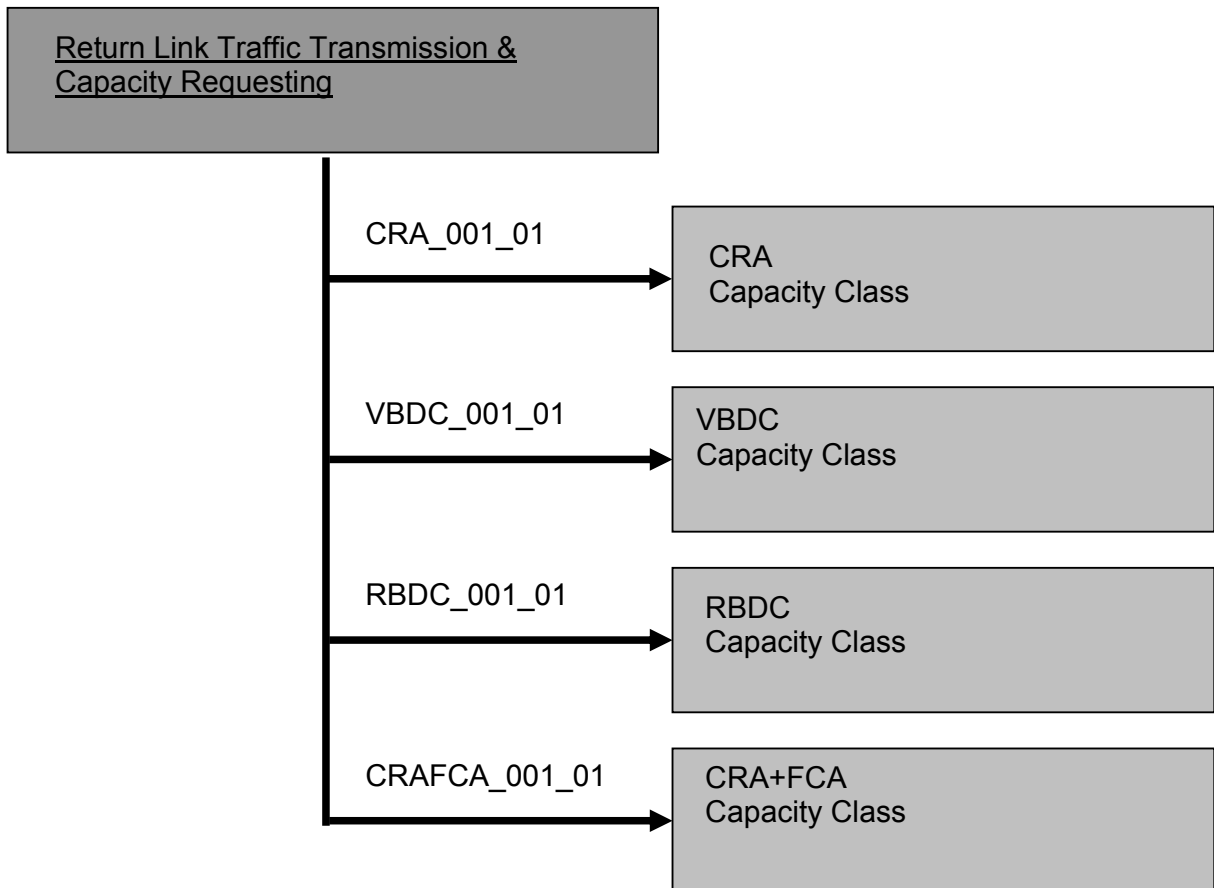

<b>Implementation of the Common Test House for DVB-RCS Terminals</b>	Doc. No: T3-061-v1	
<b>ESA Contract No: 16878/02/NL/US</b>	Version: 1.0	
	Date: 2005-11-13	

Test Case ID	CRA_001_01	
Test Case Name	CRA Capacity Class	
EN 301790 Reference	6.8.1	
Objective / Test Purpose	Verify quasi-error free UDP packet transmission over the Return Link using the CRA capacity class.	
Applicability / PICS		
Initial RCST State	Fine Sync state	
Expected Final RCST State	Fine Sync state	
Test Method	Step	Description
	1	Test system transmits $1 \cdot 10^3$ UDP packets with 1500 bytes packet size at 50 kbps at the Ethernet interface of the RCST CRA capacity shall be set to 100 kbps in the RCST TS does not allocate FCA
	2	Test system allocates corresponding TRF timeslots via TBTP
	3	RCST forwards all packets via the Return Link
	4	Test system verifies that all packets are received error-free
PASS/FAIL Criteria	<ul style="list-style-type: none"> <li>• Error-free UDP packets in step 4; Usual error occurrences as they must be expected in usual UDP transmission shall not be deemed as fail criteria for the terminal.</li> </ul>	
Remarks		

Test Case ID	VBDC_001_01	
Test Case Name	VBDC Capacity Class	
EN 301790 Reference	6.8.3	
Objective / Test Purpose	Verify quasi error-free UDP packet transmission over the Return Link using the VBDC traffic class.	
Applicability / PICS	VBDC	
Initial RCST State	Fine Sync state	
Expected Final RCST State	Fine Sync state	
Test Method	Step	Description
	1	Enable VBDC capacity requesting at RCST
	2	Test system transmits $1 \cdot 10^3$ UDP packets with 1500 bytes packet size at the Ethernet interface of the RCST. Packet rate shall be 100 kbps. CRA capacity shall be set to 0
	3	Test system allocates corresponding TRF timeslots via TBTP upon reception of a SAC field containing a VBDC request.
	4	RCST forwards all packets via the Return Link
	5	Test system verifies that all packets are received error-free
	6	Test system verifies correct formatting and content of the Capacity Requests in the SAC field of SYNC and TRF bursts
	7	Test system continuously allocates less capacity as requested to the RCST
	8	Test system verifies that the value for the requested volume units increases
PASS/FAIL Criteria	<ul style="list-style-type: none"> <li>• Error-free UDP packets in step 5; Usual error occurrences as they must be expected in usual UDP transmission shall not be deemed as fail criteria for the terminal.</li> <li>• Correctly formatted SAC field in step 6</li> <li>• Increasing value for requested volume units in step 8</li> </ul>	
Remarks	The manufacturer of the RCST is expected to provide the set of commands to force the RCST to request volume based capacity (VBDC) traffic.	



<b>Implementation of the Common Test House for DVB-RCS Terminals</b> <b>ESA Contract No: 16878/02/NL/US</b>	Doc. No: T3-061-v1 Version: 1.0 Date: 2005-11-13	
--	--	---

Test Case ID	RBDC_001_01	
Test Case Name	RBDC Capacity Class	
EN 301790 Reference	6.8.2	
Objective / Test Purpose	Verify quasi error-free UDP packet transmission over the Return Link using the RBDC traffic class.	
Applicability / PICS	RBDC	
Initial RCST State	Fine Sync state	
Expected Final RCST State	Fine Sync state	
Test Method	Step	Description
	1	Enable RBDC capacity requesting at RCST
	2	Test system transmits $1 \cdot 10^3$ UDP packets with 1500 bytes packet size at the Ethernet interface of the RCST. Packet rate shall be 100 kbps. CRA capacity shall be set to 0
	3	Test system allocates corresponding TRF timeslots via TBTP upon reception of a SAC field containing an RBDC request.
	4	RCST forwards all packets via the Return Link
	5	Test system verifies that all packets are received error-free
	6	Test system verifies correct formatting and content of the Capacity Requests in the SAC field of SYNC and TRF bursts
PASS/FAIL Criteria	<ul style="list-style-type: none"> <li>• Error-free UDP packets in step 5; Usual error occurrences as they must be expected in usual UDP transmission shall not be deemed as fail criteria for the terminal.</li> <li>• Correctly formatted SAC field in step 6.</li> </ul>	
Remarks	The manufacturer of the RCST is expected to provide the set of commands to force the RCST to request rate based capacity (RBDC) traffic.	

<b>Implementation of the Common Test House for DVB-RCS Terminals</b>	Doc. No: T3-061-v1	
<b>ESA Contract No: 16878/02/NL/US</b>	Version: 1.0	
	Date: 2005-11-13	

Test Case ID	CRAFCA_001_01	
Test Case Name	CRA+FCA Capacity Classes	
EN 301790 Reference	6.8.1, 6.8.5	
Objective / Test Purpose	Verify quasi error-free UDP packet transmission over the Return Link using combination of CRA and FCA traffic classes.	
Applicability / PICS		
Initial RCST State	Fine Sync state	
Expected Final RCST State	Fine Sync state	
Test Method	Step	Description
	1	Test system transmits $1 \cdot 10^3$ UDP packets with 1500 bytes packet size at the Ethernet interface of the RCST. CRA capacity shall be set to 50 kbps. Packet rate shall be 100 kbps
	2	Test system allocates corresponding TRF timeslots via TBTP upon reception of a SAC field containing a request.
	3	RCST forwards all packets via the Return Link
	4	Test system verifies that all packets are received error-free
	5	Test system verifies correct formatting and content of the Capacity Requests in the SAC field of SYNC and TRF bursts
PASS/FAIL Criteria	<ul style="list-style-type: none"> <li>• Error-free UDP packets in step 4; Usual error occurrences as they must be expected in usual UDP transmission shall not be deemed as fail criteria for the terminal.</li> <li>• Correctly formatted SAC field in step 6.</li> </ul>	
Remarks		

### 9.10 Logoff

This section is to ensure that a terminal is capable of logging off from the DVB-RCS network. This is a bi-directional functionality, as the terminal

- must recognise a log-off request from the network
- must be able to initiate a logoff sequence

#### Reason for having this test

Capacity in satellite interactive network is rare. Therefore, terminals should not be logged on all the time unless the users contract permits. A certain function to remotely force the terminal to log off as well as a terminal function to log off automatically after a certain time of silence is vital for a acceptable performance of the network. Most important issue with this functionality is, that the terminal ceases transmission accordingly.

**This section consists of 2 single test cases:**

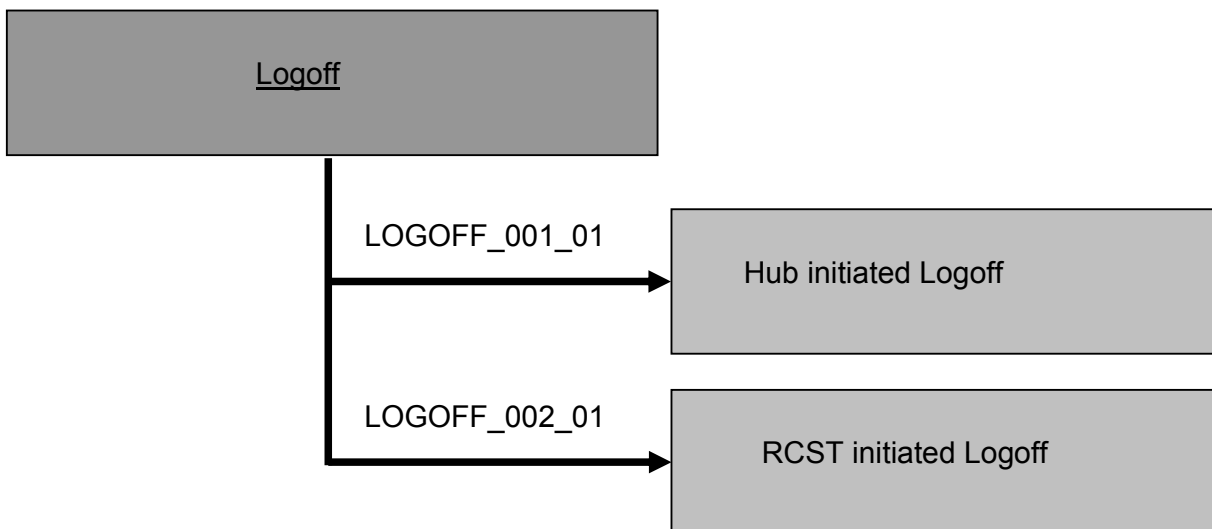

Test Case ID	LOGOFF_001_01	
Test Case Name	Hub initiated Logoff	
EN 301790 Reference	8.5.5.8	
Objective / Test Purpose	Verify correct RCST behaviour (ceasing burst transmission) when receiving a unicast TIM with information "Logoff".	
Applicability / PICS		
Initial RCST State	Fine Sync state	
Expected Final RCST State	Off / Standby	
Test Method	Step	Description
	1	Test system transmits a unicast TIM with information "Logoff" (RCST Status)
	2	RCST ceases burst transmission
	3	Test system verifies that the RCST transmits no TRF burst and no SYNC burst during the configured "wait in standby mode".
PASS/FAIL Criteria	<ul style="list-style-type: none"> <li>• No TRF or SYNC bursts in step 3</li> <li>• The RCST may re initiate logon by sending CSC bursts after the timer "wait in standby mode" expired.</li> </ul>	
Remarks	The manufacturer of the RCST is expected to provide the appropriate commands to configure the "wait in standby mode" timer.	

<b>Implementation of the Common Test House for DVB-RCS Terminals</b> <b>ESA Contract No: 16878/02/NL/US</b>	Doc. No: T3-061-v1 Version: 1.0 Date: 2005-11-13	
--	--	---

Test Case ID	LOGOFF_002_01	
Test Case Name	RCST initiated Logoff	
EN 301790 Reference	6.6.1.1	
Objective / Test Purpose	Verify proper RCST initiated logoff sequence (SAC header format, ceasing all burst transmission).	
Applicability / PICS		
Initial RCST State	Fine Sync state	
Expected Final RCST State	Off / Standby	
Test Method	Step	Description
	1	Initiate Logoff from RCST side
	2	RCST sends a Logoff Request (message 0x0002 in M&C message of the SAC field in SYNC and/or TRF burst)
	3	Test system verifies correct formatting and content of the SAC field
	4	Test system verifies no RCST burst transmission during the configured "wait in standby mode" timer
PASS/FAIL Criteria	<ul style="list-style-type: none"> <li>• No RCST bursts in step 4</li> <li>• Correctly formatted SAC field in step 3</li> <li>• The RCST may re initiate logon by sending CSC bursts after the timer "wait in standby mode" expired.</li> </ul>	
Remarks	The manufacturer of the RCST is expected to provide the appropriate commands to configure the "wait in standby mode" timer.	

### 9.11 HOLD State

In this section it is verified whether the terminal can be forced to cease transmission by sending a TIM with the "transmit\_disable" flag set to 1. Furthermore, it is verified whether the terminal remains in this status until receiving a "transmit\_disable" flag set to 0, even if meanwhile the power is switched off and on in HOLD state.

#### Reason for having this test

In a real running network it cannot be prevented that due to system or device faults, the agreed rules for return link use are violated. In those cases it must be possible to perform a well-organised trouble-shooting. Therefore there must be a functionality which allows to mute a terminal remotely. It must be ensured that a disturber can be switched off as long as its origin is clear. Once the terminal is muted, a power-cycle done by the user must not re-set the modem to the idle mode, which would allow a new sync and transmission action. The HOLD mode must not be terminated by another entity than the one which initiated the HOLD state.

This section consists of 3 single test cases:

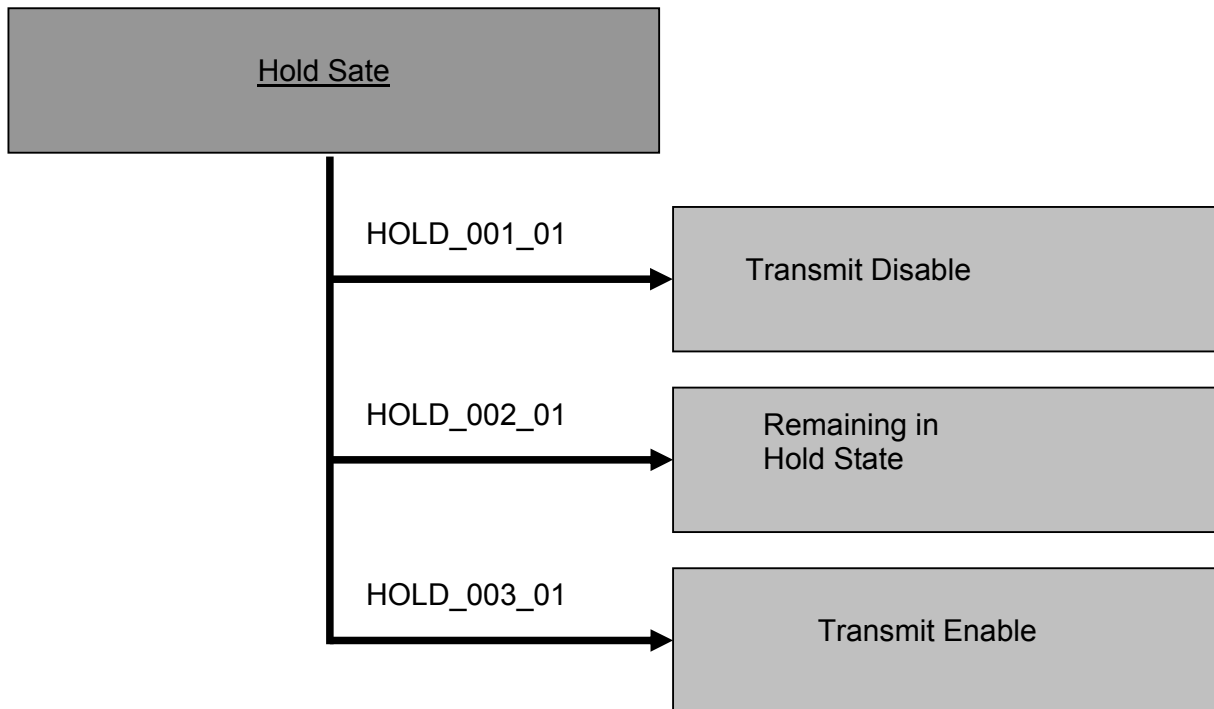

<b>Implementation of the Common Test House for DVB-RCS Terminals</b>	Doc. No: T3-061-v1 Version: 1.0	
<b>ESA Contract No: 16878/02/NL/US</b>	Date: 2005-11-13	

Test Case ID	HOLD_001_01	
Test Case Name	Transmit Disable	
EN 301790 Reference	7.1, 8.5.5.8	
Objective / Test Purpose	Verify that the RCST transitions to the Hold State upon receiving TIM with 'transmit_disable' flag set to '1'.	
Applicability / PICS		
Initial RCST State	Fine Sync state	
Expected Final RCST State	HOLD state	
Test Method	Step	Description
	1	Test system transmits a unicast TIM with 'transmit_disable' flag set to '1'
	2	RCST shall enter the Hold state
	3	Initiate Logon procedure RCST side
	4	Test system verifies no RCST burst transmission
PASS/FAIL Criteria	<ul style="list-style-type: none"> <li>No RCST bursts in step 4</li> </ul>	
Remarks	The operator shall not the reaction of the terminal (e.g. message in the management system)	

<b>Implementation of the Common Test House for DVB-RCS Terminals</b> <b>ESA Contract No: 16878/02/NL/US</b>	Doc. No: T3-061-v1 Version: 1.0 Date: 2005-11-13	
--	--	---

Test Case ID	HOLD_002_01	
Test Case Name	Remaining in HOLD State	
EN 301790 Reference	7.1	
Objective / Test Purpose	Verify that the RCST being in HOLD state and after power-off and power-on remains in this state and does not send any burst.	
Applicability / PICS		
Initial RCST State	HOLD state	
Expected Final RCST State	HOLD state	
Test Method	Step	Description
	1	Initiate RCST power off and power on
	2	Initiate Logon procedure at RCST side
	3	Test system verifies no RCST burst transmission
PASS/FAIL Criteria	<ul style="list-style-type: none"> <li>No RCST bursts in step 3</li> </ul>	
Remarks	After power-on the RCST may acquire the Forward Link.	



<b>Implementation of the Common Test House for DVB-RCS Terminals</b>	Doc. No: T3-061-v1 Version: 1.0	
<b>ESA Contract No: 16878/02/NL/US</b>	Date: 2005-11-13	

Test Case ID	HOLD_003_01	
Test Case Name	Transmit Enable	
EN 301790 Reference	7.1, 8.5.5.8	
Objective / Test Purpose	Verify that the RCST being in HOLD state returns to the Receive Sync state upon receiving TIM with 'transmit_disable' flag set to '0'.	
Applicability / PICS		
Initial RCST State	HOLD state	
Expected Final RCST State	Receive Sync state	
Test Method	Step	Description
	1	Test system transmits a unicast TIM with 'transmit_disable' flag set to '0'
	2	Initiate Logon procedure at RCST side
	3	Test system verifies that RCST starts CSC burst transmission
PASS/FAIL Criteria	<ul style="list-style-type: none"> <li>• CSC bursts in step 3</li> </ul>	
Remarks	For the case that this test case would fail (the terminal would not return to normal operation anymore) the manufacturer shall provide measures to re-activate the terminal. Such measures shall only be accessible in the testing and shall not be deemed as consumer feature in end-products.	

<b>Implementation of the Common Test House for DVB-RCS Terminals</b>	Doc. No: T3-061-v1 Version: 1.0	
<b>ESA Contract No: 16878/02/NL/US</b>	Date: 2005-11-13	

## 9.12 SI Tables

The SI tables are of very specific interest in DVB-RCS networks as the complete return channel is organised via this tables. Only if all connected terminals do accept changes in the SI tables immediately it can be ensured, that the capacity of the return channel is used without signal conflicts.

In this section variations of the various tables (SCT, FCT, TCT) and the impact of these variations to the terminal are tested.

### Reason for having this test

The return channel forms a shared media channel. All the participants in this shared medium must have the same information on the structure of the return channel. Only if all the participants (connected terminals) do interpret the SI tables correctly, the simultaneous use of the return channel (including the common signalling channels and sync bursts) by several terminals is possible.

**Note 1:** In almost all of the following test cases parameters of DVB-RCS specific SI Tables shall be modified. This requires modification in related other tables e.g. TBTP. These modifications are not explicitly described in the test cases.

**Note 2:** Between each parameter change the RCST shall establish a new session. Even a reboot between changes shall be allowed (e.g no dynamical change of the frame structure).

**Note 3:** Only those parameters shall be tested which are declared by the manufacturer in the PIXIT table.

This section consists of 43 single test cases, of which 4 are allocated to the SCT manipulation:

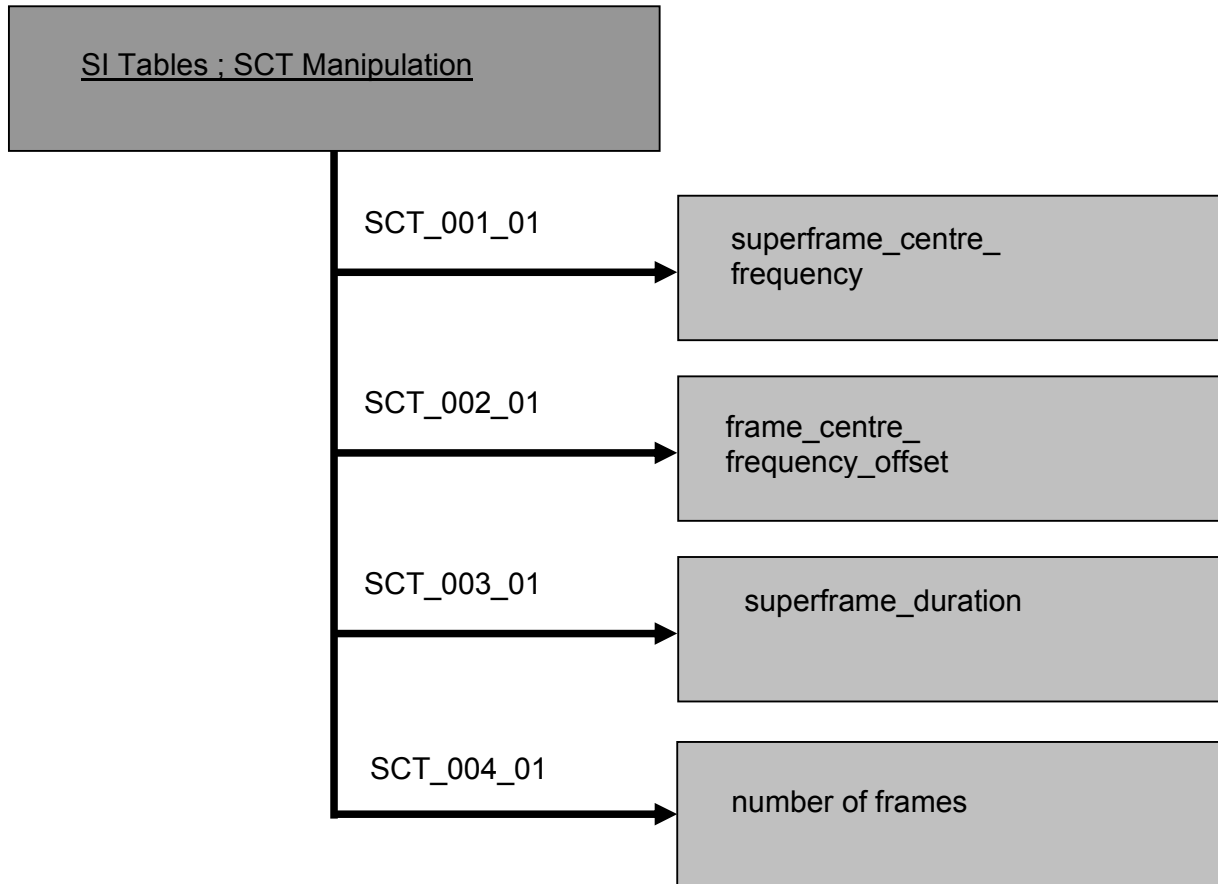

<b>Implementation of the Common Test House for DVB-RCS Terminals</b>	Doc. No: T3-061-v1	
<b>ESA Contract No: 16878/02/NL/US</b>	Version: 1.0	
	Date: 2005-11-13	

Test Case ID	SCT_001_01	
Test Case Name	Changes in SCT, superframe_centre_frequency	
EN 301790 Reference	8.3.1.1, 8.5.5.2, 6.1.3	
Objective / Test Purpose	Verify the correct reception and interpretation of the RCST when in the SCT the value of "superframe_centre_frequency" has changed from the default value to the upper and lower edge value.	
Applicability / PICS	-	
Initial RCST State	Off/Stand-by	
Expected Final RCST State	Off/Stand-by	
Test Method	Step	Description
	1	Test system transmits SCT with default value for superframe_centre_frequency
	2	Start RCST logon procedure
	3	Initiate IP traffic from Host PC at RCST side
	4	Test system verifies RCST's transmit activities. Test system verifies that the RCST is only transmitting in allocated timeslots.
	5	Test System initiate RCST logoff
	6	Change superframe_centre_frequency and distribute the new value in SCT
	7	Proceed with step 2 until procedure is done for lowest and highest superframe_centre_frequency
	8	End
PASS/FAIL Criteria	<ul style="list-style-type: none"> <li>• Test procedure is fulfilled.</li> <li>• RCST has achieved fine sync state in step 4.</li> <li>• Traffic is transported in step 4.</li> </ul>	
Remerks		

<b>Implementation of the Common Test House for DVB-RCS Terminals</b>	Doc. No: T3-061-v1	
<b>ESA Contract No: 16878/02/NL/US</b>	Version: 1.0	
	Date: 2005-11-13	

Test Case ID	SCT_002_01	
Test Case Name	Changes in SCT, frame_centre_frequency_offset	
EN 301790 Reference	8.3.1.1, 8.5.5.2	
Objective / Test Purpose	Verify the correct reception and interpretation of the RCST when in the SCT the content of "frame_centre_frequency_offset" for all frames has changed from the default value, verified at the default superframe_centre_frequency.	
Applicability / PICS	-	
Initial RCST State	Off/Stand-by	
Expected Final RCST State	Off/Stand-by	
Test Method	Step	Description
	1	Test system transmits SCT with default value for frame_centre_frequency_offset
	2	Start RCST logon procedure
	3	Initiate IP traffic from Host PC at RCST side
	4	Test system verifies RCST's transmit activities. Test system verifies that the RCST is transmitting only in allocated timeslots.
	5	Test System initiates RCST logoff
	6	Change frame_centre_frequency_offset and distribute the new value in SCT
	7	Proceed with step 2 until procedure is done for a positive and a negative shift of the frame_centre_frequency.
	8	End
PASS/FAIL Criteria	<ul style="list-style-type: none"> <li>• Test procedure is fulfilled.</li> <li>• RCST has achieved fine sync state in step 4.</li> <li>• Traffic is transported in step 4.</li> </ul>	
Remarks		

<b>Implementation of the Common Test House for DVB-RCS Terminals</b>	Doc. No: T3-061-v1 Version: 1.0	
<b>ESA Contract No: 16878/02/NL/US</b>	Date: 2005-11-13	

Test Case ID	SCT_003_01	
Test Case Name	Changes in SCT, superframe_duration	
EN 301790 Reference	8.3.1.1, 8.5.5.2, 6.1.3	
Objective / Test Purpose	Verify the correct reception and interpretation of the RCST when in the SCT the content of "superframe_duration" has changed from the default value to the upper and lower edge value.	
Applicability / PICS	-	
Initial RCST State	Off/Stand-by	
Expected Final RCST State	Off/Stand-by	
Test Method	Step	Description
	1	Test system transmits SCT with default value for superframe_duration
	2	Start RCST logon procedure
	3	Initiate IP traffic from Host PC at RCST side
	4	Test system verifies RCST's transmit activities. Test system verifies that the RCST is only transmitting in allocated timeslots.
	5	Test System initiates RCST logoff
	6	Change superframe_duration and distribute the new value in SCT
	7	Proceed with step 2 until procedure is done for lowest and highest specified value for superframe_duration
	8	End
PASS/FAIL Criteria	<ul style="list-style-type: none"> <li>• Test procedure is fulfilled.</li> <li>• RCST has achieved fine sync state in step 4.</li> <li>• Traffic is transported in step 4.</li> </ul>	
Remarks		

<b>Implementation of the Common Test House for DVB-RCS Terminals</b>	Doc. No: T3-061-v1	
<b>ESA Contract No: 16878/02/NL/US</b>	Version: 1.0	
	Date: 2005-11-13	

Test Case ID	SCT_004_01	
Test Case Name	Changes in SCT, number of frames	
EN 301790 Reference	8.3.1.1, 8.5.5.2, 6.1.3	
Objective / Test Purpose	Verify the correct reception and interpretation of the RCST when in the SCT the content of "frame_loop_count" has changed from the default value to the upper and lower edge value.	
Applicability / PICS	-	
Initial RCST State	Off/Stand-by	
Expected Final RCST State	Off/Stand-by	
Test Method	Step	Description
	1	Test system transmits SCT with default value for frame_loop_count
	2	Start RCST logon procedure
	3	Initiate IP traffic from Host PC at RCST side
	4	Test system verifies RCST's transmit activities. Test system verifies that the RCST is transmitting only in allocated timeslots.
	5	Test System initiates RCST logoff
	6	Change frame_loop_count and distribute the new value in SCT
	7	Proceed with step 2 until procedure is done for lowest and highest specified value for frame_loop_count
	8	End
PASS/FAIL Criteria	<ul style="list-style-type: none"> <li>• Test procedure is fulfilled.</li> <li>• RCST has achieved fine sync state in step 4.</li> <li>• Traffic is transported in step 4.</li> </ul>	
Remarks		

This section consists of 43 single test cases, of which 4 are allocated to the FCT manipulation:

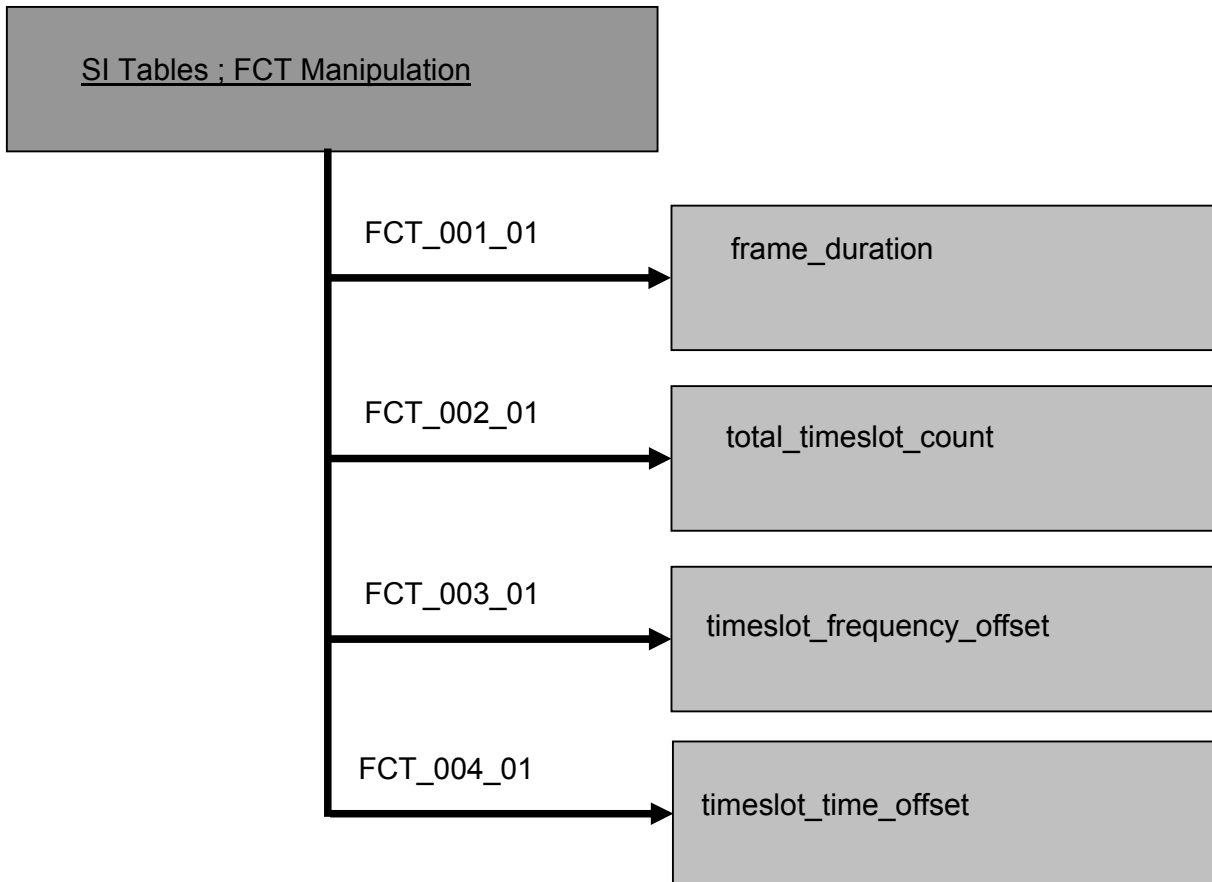



<b>Implementation of the Common Test House for DVB-RCS Terminals</b>	Doc. No: T3-061-v1	
<b>ESA Contract No: 16878/02/NL/US</b>	Version: 1.0	
	Date: 2005-11-13	

Test Case ID	FCT_001_01	
Test Case Name	Change in FCT, frame_duration	
EN 301790 Reference	8.3.1.2, 8.5.5.3, 6.1.3	
Objective / Test Purpose	Verify the correct reception and interpretation of the RCST when in the FCT the value of "frame_duration" has changed from the default value to the upper and lower edge value.	
Applicability / PICS	-	
Initial RCST State	Off/Stand-by	
Expected Final RCST State	Off/Stand-by	
Test Method	Step	Description
	1	Test system transmits FCT with default value for frame_duration
	2	Start RCST logon procedure
	3	Initiate IP traffic from Host PC at RCST side
	4	Test system verifies RCST's transmit activities. Test system verifies that the RCST is only transmitting in allocated timeslots.
	5	Test system initiates RCST logoff
	6	Change frame_duration and distribute the new value in FCT
	7	Proceed with step 2 until procedure is done for lowest and highest specified value for frame_duration
	8	End
PASS/FAIL Criteria	<ul style="list-style-type: none"> <li>• Test procedure is fulfilled.</li> <li>• RCST has achieved fine sync state in step 4.</li> <li>• Traffic is transported in step 4.</li> </ul>	
Remarks		

<b>Implementation of the Common Test House for DVB-RCS Terminals</b>	Doc. No: T3-061-v1	
<b>ESA Contract No: 16878/02/NL/US</b>	Version: 1.0	
	Date: 2005-11-13	

Test Case ID	FCT_002_01	
Test Case Name	Change in FCT, total_timeslot_count	
EN 301790 Reference	8.3.1.2, 8.5.5.3, 6.1.3	
Objective / Test Purpose	Verify the correct reception and interpretation of the RCST when in the FCT the value of "total_timeslot_count" has changed from the default value to the upper and lower edge value.	
Applicability / PICS	-	
Initial RCST State	Off/Stand-by	
Expected Final RCST State	Off/Stand-by	
Test Method	Step	Description
	1	Test system transmits FCT with default value for total_timeslot_count
	2	Start RCST logon procedure
	3	Initiate IP traffic from Host PC at RCST side
	4	Test system verifies RCST's transmit activities. Test system verifies that the RCST is only transmitting in allocated timeslots.
	5	Test system initiates RCST logoff
	6	Change total_timeslot_count and distribute the new value in FCT
	7	Proceed with step 2 until procedure is done for lowest and highest specified value for total_timeslot_count
	8	End
PASS/FAIL Criteria	<ul style="list-style-type: none"> <li>• Test procedure is fulfilled.</li> <li>• RCST has achieved fine sync state in step 4.</li> <li>• Traffic is transported in step 4.</li> </ul>	
Remarks		

<b>Implementation of the Common Test House for DVB-RCS Terminals</b>	Doc. No: T3-061-v1	
<b>ESA Contract No: 16878/02/NL/US</b>	Version: 1.0	
	Date: 2005-11-13	

Test Case ID	FCT_003_01	
Test Case Name	Change in FCT, timeslot_frequency_offset	
EN 301790 Reference	8.3.1.2, 8.5.5.3, 6.1.3	
Objective / Test Purpose	Verify the correct reception and interpretation of the RCST when in the FCT the value of "timeslot_frequency_offset" has changed from the default value to the upper and lower edge value; superframe_centre_fequency_offset and frame_centre_frequency_offset shall remain at a fixed value.	
Applicability / PICS	-	
Initial RCST State	Off/Stand-by	
Expected Final RCST State	Off/Stand-by	
Test Method	Step	Description
	1	Test system transmits FCT with default value for timeslot_frequency_offset
	2	Start RCST logon procedure
	3	Initiate IP traffic from Host PC at RCST side
	4	Test system verifies RCST's transmit activities. Test system verifies that the RCST is only transmitting in allocated timeslots.
	5	Test system initiates RCST logoff
	6	Change timeslot_frequency_offset and distribute the new value in FCT
	7	Proceed with step 2 until procedure is done for a positive and a negative shift of the timeslot_frequency_offset
	8	End
PASS/FAIL Criteria	<ul style="list-style-type: none"> <li>• Test procedure is fulfilled.</li> <li>• RCST has achieved fine sync state in step 4.</li> <li>• Traffic is transported in step 4.</li> </ul>	
Remarks		

<b>Implementation of the Common Test House for DVB-RCS Terminals</b>	Doc. No: T3-061-v1 Version: 1.0	
<b>ESA Contract No: 16878/02/NL/US</b>	Date: 2005-11-13	

Test Case ID	FCT_004_01	
Test Case Name	Change in FCT, timeslot_time_offset	
EN 301790 Reference	8.3.1.2, 8.5.5.3, 6.1.3	
Objective / Test Purpose	Verify the correct reception and interpretation of the RCST when in the FCT the value of "timeslot_time_offset" has changed from the default value to the upper and lower edge value.	
Applicability / PICS	-	
Initial RCST State	Off/Stand-by	
Expected Final RCST State	Off/Stand-by	
Test Method	Step	Description
	1	Test system transmits FCT with default value for timeslot_time_offset
	2	Start RCST logon procedure
	3	Initiate IP traffic from Host PC at RCST side
	4	Test system verifies RCST's transmit activities. Test system verifies that the RCST is only transmitting in allocated timeslots.
	5	Test system initiates RCST logoff
	6	Change timeslot_time_offset and distribute the new value in FCT
	7	Proceed with step 2 until procedure is done for the minimum shift (0, equal to the default setting) and a positive shift of several ms.
8	End	
PASS/FAIL Criteria	<ul style="list-style-type: none"> <li>• Test procedure is fulfilled.</li> <li>• RCST has achieved fine sync state in step 4.</li> <li>• Traffic is transported in step 4.</li> </ul>	
Remarks		

This section consists of 43 single test cases, of which 23 are allocated to the TCT manipulation:

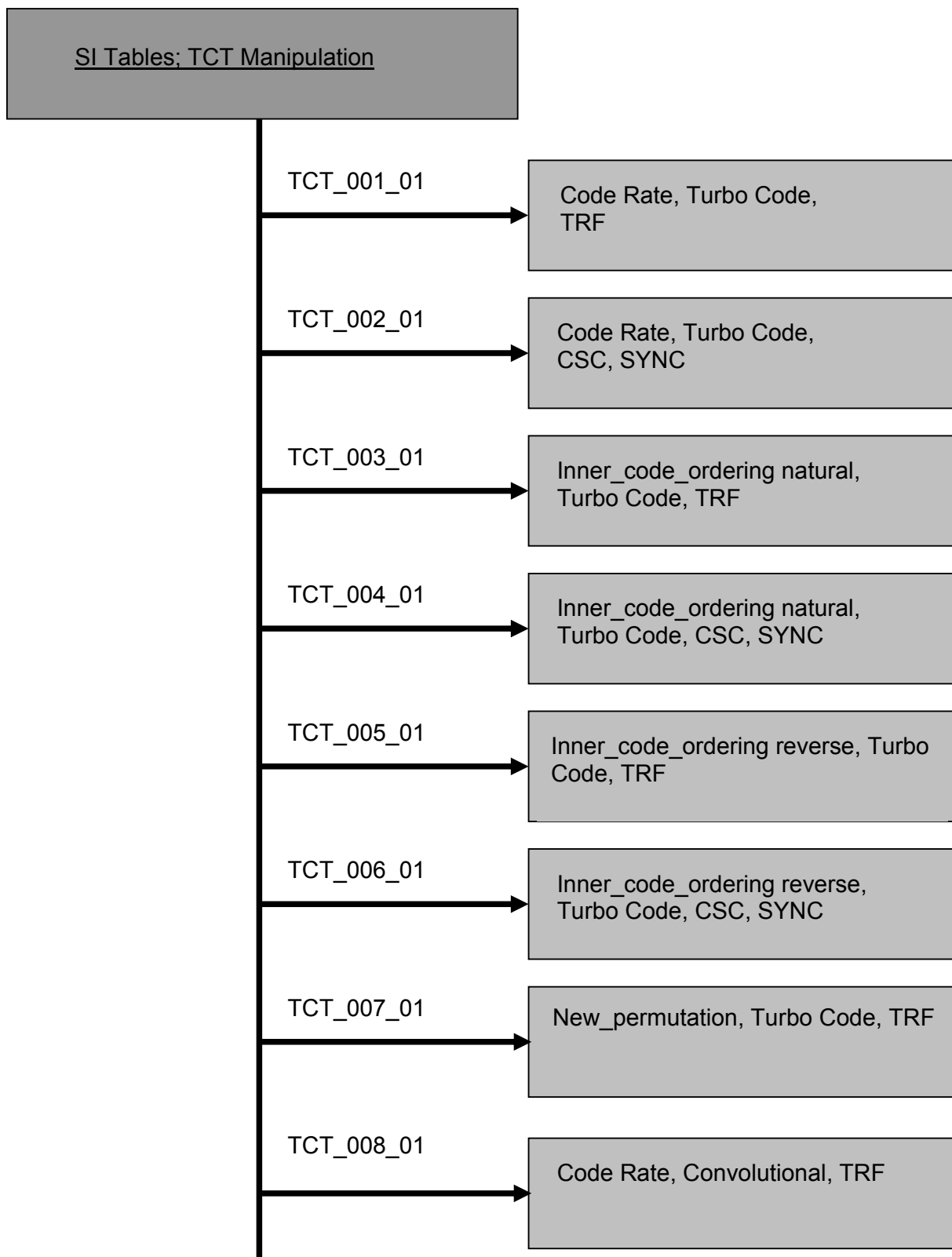

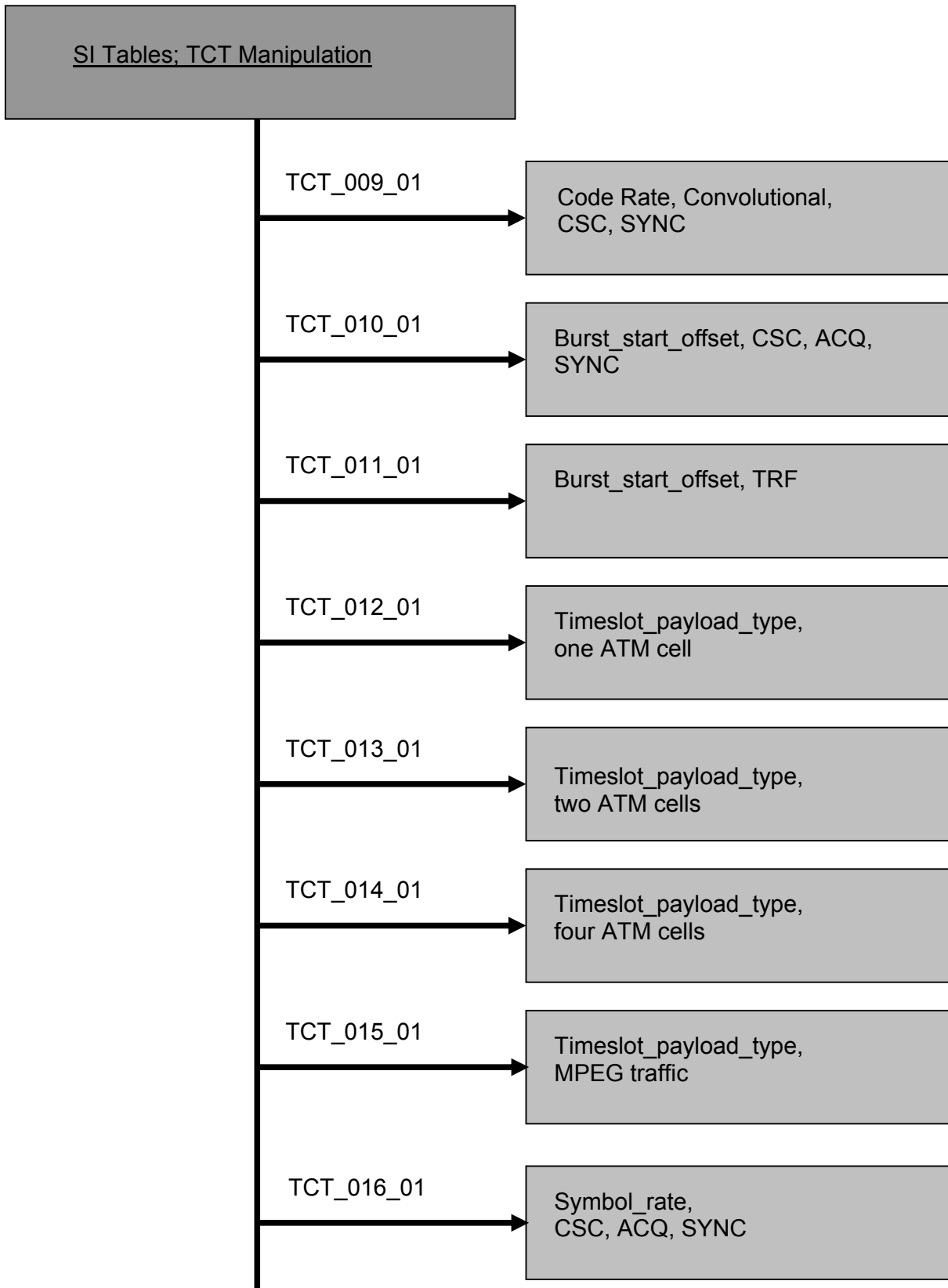

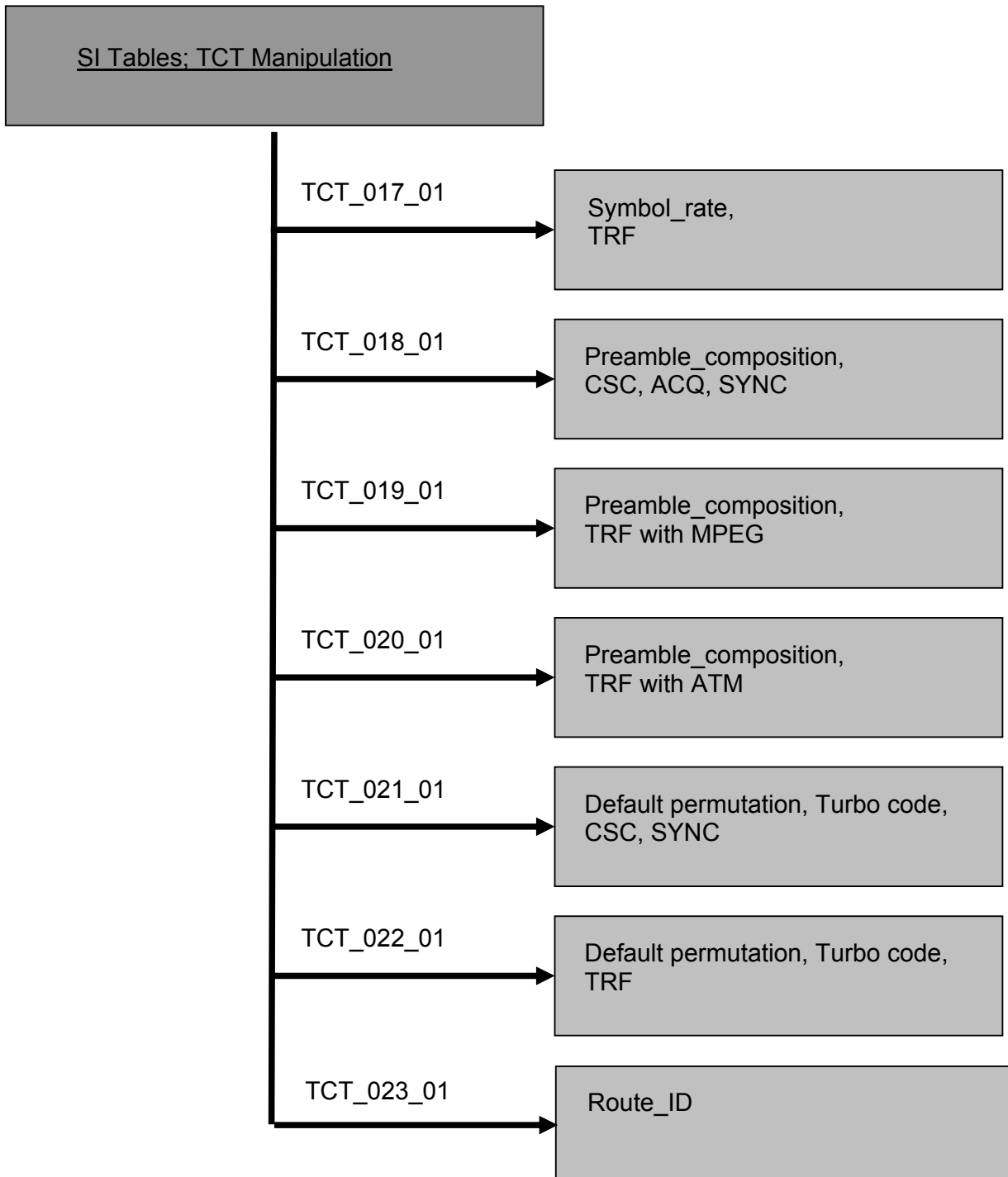

Test Case ID	TCT_001_01	
Test Case Name	Change in TCT, Code Rate, Turbo Code, TRF	
EN 301790 Reference	8.5.5.4	
Objective / Test Purpose	Verify the correct reception and interpretation of the RCST when in the TCT the value of "inner_coding_puncturing" has changed from the default value to the upper and lower edge value for TRF bursts. Turbo code is used as inner code type. The symbol rate should not vary during test.	
Applicability / PICS	-	
Initial RCST State	Off/Stand-by	
Expected Final RCST State	Off/Stand-by	
Test Method	Step	Description
	1	Test system transmits TCT with default value of inner_coding_puncturing. Turbo code is selected as inner code type
	2	Start RCST logon procedure
	3	Initiate IP traffic from Host PC at RCST side
	4	Test system verifies correct RCST TRF coding. Test system verifies RCST's transmit activities. Test system verifies that the RCST is only transmitting in allocated timeslots.
	5	Test system initiates RCST logoff
	6	Change inner_coding_puncturing and distribute the new value in TCT
	7	Proceed with step 2 until procedure is done for all specified settings for the inner_code_puncturing
	8	End
PASS/FAIL Criteria	<ul style="list-style-type: none"> <li>• Test procedure is fulfilled.</li> <li>• RCST has achieved fine sync state in step 4.</li> <li>• Traffic is transported in step 4.</li> <li>• RCST uses correct TRF coding in step 4.</li> </ul>	
Remarks		



Test Case ID	TCT_002_01	
Test Case Name	Change in TCT, Code_Rate, Turbo Code, CSC, SYNC	
EN 301790 Reference	8.5.5.4	
Objective / Test Purpose	Verify the correct reception and interpretation of the RCST when in the TCT the value of "inner_coding_puncturing" has changed from the default value to the upper and lower edge value for CSC and SYNC bursts. Turbo code is used as inner code type. The symbol rate should not vary during test.	
Applicability / PICS	-	
Initial RCST State	Off/Stand-by	
Expected Final RCST State	Off/Stand-by	
Test Method	Step	Description
	1	Test system transmits TCT with default value of inner_coding_puncturing. Turbo code is selected as inner code type
	2	Start RCST logon procedure
	3	Test system verifies correct CSC and SYNC burst coding.
	4	Test system initiates RCST logoff
	5	Change inner_coding_puncturing and distribute the new value in TCT
	6	Proceed with step 2 until procedure is done for all specified values for the inner_coding_puncturing for bursts other than TRF.
	7	End
PASS/FAIL Criteria	<ul style="list-style-type: none"> <li>• Test procedure is fulfilled.</li> <li>• RCST uses correct CSC and SYNC burst coding in step 3.</li> </ul>	
Remarks		

Test Case ID	TCT_003_01	
Test Case Name	Change in TCT, Inner_code_ordering natural, turbo code, TRF	
EN 301790 Reference	8.5.5.4	
Objective / Test Purpose	Verify the correct reception and interpretation of the RCST when in the TCT natural as inner code ordering mode is signaled for TRF bursts. Turbo code is used as inner code type. The symbol and code rate should not vary during test.	
Applicability / PICS	-	
Initial RCST State	Off/Stand-by	
Expected Final RCST State	Fine sync state	
Test Method	Step	Description
	1	Test system is signalling Turbo code as inner_code_type and natural order as inner_code_ordering via TCT for all TRF bursts
	2	Start RCST logon procedure
	3	Initiate IP traffic from Host PC at RCST side
	4	Test system verifies correct RCST TRF coding
PASS/FAIL Criteria	<ul style="list-style-type: none"> <li>• Test procedure is fulfilled</li> <li>• RCST uses correct TRF coding in step 4.</li> <li>• RCST has achieved fine sync state in step 4.</li> <li>• Traffic is transported in step 4.</li> </ul>	
Remarks		

<b>Implementation of the Common Test House for DVB-RCS Terminals</b>	Doc. No: T3-061-v1	
<b>ESA Contract No: 16878/02/NL/US</b>	Version: 1.0	
	Date: 2005-11-13	

Test Case ID	TCT_004_01	
Test Case Name	Change in TCT, Inner_code_ordering natural, turbo code, CSC and SYNC	
EN 301790 Reference	8.5.5.4	
Objective / Test Purpose	Verify the correct reception and interpretation of the RCST when in the TCT natural as inner code ordering mode is signaled for CSC and SYNC bursts. Turbo code is used as inner code type. The symbol- and code rate should not vary during test.	
Applicability / PICS	-	
Initial RCST State	Off/Stand-by	
Expected Final RCST State	Fine sync state	
Test Method	Step	Description
	1	Test system is signalling Turbo code as inner_code_type and natural order as inner_code_ordering via TCT for CSC and SYNC bursts.
	2	Start RCST logon procedure
	3	Test system verifies, that RCST uses correct CSC and SYNC burst coding
PASS/FAIL Criteria	<ul style="list-style-type: none"> <li>• Test procedure is fulfilled</li> <li>• RCST uses correct CSC and SYNC burst coding in step 3.</li> </ul>	
Remarks		

<b>Implementation of the Common Test House for DVB-RCS Terminals</b> <b>ESA Contract No: 16878/02/NL/US</b>	Doc. No: T3-061-v1 Version: 1.0 Date: 2005-11-13	
--	--	---

Test Case ID	TCT_005_01	
Test Case Name	Change in TCT, Inner_code_ordering reverse, turbo code, TRF	
EN 301790 Reference	8.5.5.4	
Objective / Test Purpose	Verify the correct reception and interpretation of the RCST when in the TCT reverse as inner code ordering mode is signaled for TRF bursts. Turbo code is used as inner code type. The symbol and code rate should not vary during test.	
Applicability / PICS	-	
Initial RCST State	Off/Stand by	
Expected Final RCST State	Fine sync state	
Test Method	Step	Description
	1	Test system is signalling Turbo code as inner_code_type and reverse order as inner_code_ordering via TCT
	2	Start RCST logon procedure
	3	Initiate IP traffic from Host PC at RCST side
	4	Test system verifies correct RCST TRF coding
PASS/FAIL Criteria	Test procedure is fulfilled. RCST uses correct TRF coding in step4.	
Remarks	This test case is obsolete, after SatLabs decided, that reverse order need not be supported by Satlabs recommended terminals.	

Test Case ID	TCT_006_01	
Test Case Name	Change in TCT, Inner_code_ordering reverse, turbo code, CSC, SYNC	
EN 301790 Reference	8.5.5.4	
Objective / Test Purpose	Verify the correct reception and interpretation of the RCST when in the TCT reverse as inner code ordering mode is signaled for CSC and SYNC bursts. Turbo code is used as inner code type. The symbol and code rate should not vary during test.	
Applicability / PICS	-	
Initial RCST State	Off/Stand by	
Expected Final RCST State	Fine sync state	
Test Method	Step	Description
	1	Test system is signalling Turbo code as inner_code_type and reverse order as inner_code_ordering via TCT
	2	Start RCST logon procedure
	3	Test system verifies correct RCST CSC and SYNC burst coding
PASS/FAIL Criteria	Test procedure is fulfilled. RCST uses correct CSC and SYNC burst coding in step3	
Remarks	This test case is obsolete, after SatLabs decided, that reverse order need not be supported by Satlabs recommended terminals.	

Implementation of the Common Test House for DVB-RCS Terminals	Doc. No: T3-061-v1	
ESA Contract No: 16878/02/NL/US	Version: 1.0	
	Date: 2005-11-13	

Test Case ID	TCT_007_01	
Test Case Name	Change in TCT, New_permutation, Turbo Code, TRF	
EN 301790 Reference	8.5.5.4	
Objective / Test Purpose	Verify the correct reception and interpretation of the RCST when in the TCT new_permutation bit is set to 1 for TRF bursts. All possible values for P0, P1, P2, P3 should be tested. Turbo code is used as inner code type	
Applicability / PICS	-	
Initial RCST State	Off/Stand-by	
Expected Final RCST State	Fine sync state	
Test Method	Step	Description
	1	Test system transmits TCT with new_permutation_bit set to 0 (default permutation) Test system is signalling turbo code as inner_code_type in TCT.
	2	Start RCST logon procedure
	3	Initiate IP traffic from Host PC at RCST side
	4	Test system verifies correct RCST TRF coding. Test system verifies RCST's transmit activities. Test system verifies that the RCST is only transmitting in allocated timeslots.
	5	Test system initiates RCST logoff
	6	Test system provides a TCT with new_permutation_bit set to 1 (new permutation) and the values P0,P1,P2,P3 set to the appropriate new values and distributes the new TCT
	7	Proceed with step 2 until procedure is done all specified values for P0, P1, P2, P3
	8	End
PASS/FAIL Criteria	<ul style="list-style-type: none"> <li>• Test procedure is fulfilled</li> <li>• RCST uses correct TRF coding in step 4.</li> <li>• Traffic is transported in step 4.</li> </ul>	
Remarks	This TC has been deleted caused by decision made in SatLabs (see SSR v1.2.4)	

Test Case ID	TCT_008_01	
Test Case Name	Change in TCT, Code rate, Convolutional, TRF	
EN 301790 Reference	8.5.5.4	
Objective / Test Purpose	Verify the correct reception and interpretation of the RCST when in the TCT the value of "inner_coding_puncturing" has changed from the default value to the upper and lower edge value for TRF bursts. Convolutional code is used as inner code type. The symbol rate should not vary during test.	
Applicability / PICS	CONV_RS	
Initial RCST State	Off/Stand-by	
Expected Final RCST State	Off/Stand-by	
Test Method	Step	Description
	1	Test system transmits TCT with default value of inner_coding_puncturing. Convolutional code is selected as inner code type
	2	Start RCST logon procedure
	3	Initiate IP traffic from Host PC at RCST side
	4	Test system verifies correct RCST TRF coding. Test system verifies RCST's transmit activities. Test system verifies that the RCST is only transmitting in allocated timeslots.
	5	Test system initiates RCST logoff
	6	Change inner_coding_puncturing and distribute the new value in TCT
	7	Proceed with step 2 until procedure is done for all specified settings for the inner_code_puncturing
	8	End
PASS/FAIL Criteria	<ul style="list-style-type: none"> <li>• Test procedure is fulfilled</li> <li>• RCST uses correct TRF coding in step 4.</li> <li>• Traffic is transported in step 4.</li> </ul>	
Remarks		

<b>Implementation of the Common Test House for DVB-RCS Terminals</b>	Doc. No: T3-061-v1 Version: 1.0	
<b>ESA Contract No: 16878/02/NL/US</b>	Date: 2005-11-13	

Test Case ID	TCT_009_01	
Test Case Name	Change in TCT, Code rate, Convolutional, CSC, SYNC	
EN 301790 Reference	8.5.5.4	
Objective / Test Purpose	Verify the correct reception and interpretation of the RCST when in the TCT the value of "inner_coding_puncturing" has changed from the default value to the upper and lower edge value for CSC and SYNC bursts. Convolutional code is used as inner code type. The symbol rate should not vary during test.	
Applicability / PICS	CONV_RS	
Initial RCST State	Off/Stand-by	
Expected Final RCST State	Off/Stand-by	
Test Method	Step	Description
	1	Test system transmits TCT with default value of inner_coding_puncturing. Convolutional code is selected as inner code type
	2	Start RCST logon procedure
	3	Test system verifies correct CSC and SYNC burst coding.
	4	Test system initiates RCST logoff
	5	Change inner_coding_puncturing and distribute the new value in TCT
	6	Proceed with step 2 until procedure is done for all specified values for the inner_coding_puncturing for bursts other than TRF.
	7	End
PASS/FAIL Criteria	<ul style="list-style-type: none"> <li>• Test procedure is fulfilled.</li> <li>• RCST uses correct CSC and SYNC burst coding in step 3.</li> </ul>	
Remarks		



<b>Implementation of the Common Test House for DVB-RCS Terminals</b>	Doc. No: T3-061-v1	
<b>ESA Contract No: 16878/02/NL/US</b>	Version: 1.0	
	Date: 2005-11-13	

Test Case ID	TCT_010_01	
Test Case Name	Change in TCT, burst_start_offset, CSC, ACQ, SYNC	
EN 301790 Reference	8.3.1.3, 8.5.5.4	
Objective / Test Purpose	Verify the correct reception and interpretation of the RCST when in the TCT the value of "burst_start_offset" has changed from the default value to the upper and lower edge value for CSC, ACQ and SYNC bursts.	
Applicability / PICS	-	
Initial RCST State	Off/Stand-by	
Expected Final RCST State	Off/Stand-by	
Test Method	Step	Description
	1	Test system transmits TCT with default value for burst_start_offset.
	2	Start RCST logon procedure
	3	Test system verifies correct CSC, ACQ and SYNC burst traffic (ACQ only if applicable)
	4	Test System initiates RCST logoff
	5	Change burst_start_offset and distribute the new value in TCT
	6	Proceed with step 2 until procedure is done for lowest and highest possible value for burst_start_offset according to the used Timeslot lengths.
PASS/FAIL Criteria	7	End
	<ul style="list-style-type: none"> <li>• Test procedure is fulfilled.</li> <li>• RCST `s burst synchronization accuracy for all burst types shall be within the expected burst window (see SYNC Achieved Thresholds)</li> </ul>	
Remarks		

<b>Implementation of the Common Test House for DVB-RCS Terminals</b>	Doc. No: T3-061-v1	
<b>ESA Contract No: 16878/02/NL/US</b>	Version: 1.0	
	Date: 2005-11-13	

Test Case ID	TCT_011_01	
Test Case Name	Change in TCT, burst_start_offset, TRF	
EN 301790 Reference	8.3.1.3, 8.5.5.4	
Objective / Test Purpose	Verify the correct reception and interpretation of the RCST when in the TCT the value of "burst_start_offset" has changed from the default value to the upper and lower edge value for TRF bursts.	
Applicability / PICS	-	
Initial RCST State	Off/Stand-by	
Expected Final RCST State	Off/Stand-by	
Test Method	Step	Description
	1	Test system transmits TCT with default value for burst_start_offset
	2	Start RCST logon procedure
	3	Initiate IP traffic from Host PC at RCST side
	4	Test system verifies correct RCST TRF coding. Test system verifies RCST's transmit activities. Test system verifies that the RCST is only transmitting in allocated timeslots.
	5	Perform step 4 for at least 3 minutes
	6	Test system initiates RCST logoff
	7	Change burst_start_offset and distribute the new value in TCT
	8	Proceed with step 2 until procedure is done for lowest and highest possible value for burst_start_offset according to the used TCT definition (min_guard_start and min_guard_end)
	9	End
PASS/FAIL Criteria	<ul style="list-style-type: none"> <li>• Test procedure is fulfilled.</li> <li>• RCST `s burst synchronization accuracy for all burst types shall be within the expected burst window (see SYNC Achieved Thresholds).</li> <li>• Traffic is transported in step 4</li> </ul>	
Remarks		

<b>Implementation of the Common Test House for DVB-RCS Terminals</b>	Doc. No: T3-061-v1	
<b>ESA Contract No: 16878/02/NL/US</b>	Version: 1.0	
	Date: 2005-11-13	

Test Case ID	TCT_012_01	
Test Case Name	Change in TCT, timeslot_payload_type, one ATM cell	
EN 301790 Reference	8.3.1.3, 8.5.5.4	
Objective / Test Purpose	Verify the correct reception and interpretation of the RCST when ATM traffic with one ATM cell is signalled via "timeslot_payload_type" in TCT for TRF bursts.	
Applicability / PICS	Only for ATM Profiles	
Initial RCST State	Off/Stand-by	
Expected Final RCST State	Fine sync state	
Test Method	Step	Description
	1	Test system is signalling TRF with one ATM cell in TCT. Timeslot type value 0x01
	2	Start RCST logon procedure
	3	Initiate IP traffic from Host PC at RCST side
	4	Test system verifies correct RCST's TRF burst composition. Test system verifies RCST's transmit activities. Test system verifies that the RCST is only transmitting in allocated timeslots.
PASS/FAIL Criteria	<ul style="list-style-type: none"> <li>• Test procedure is fulfilled.</li> <li>• RCST is correctly assembling TRF slots in step 4</li> <li>• (one ATM cell).</li> </ul>	
Remarks		

<b>Implementation of the Common Test House for DVB-RCS Terminals</b>	Doc. No: T3-061-v1	
<b>ESA Contract No: 16878/02/NL/US</b>	Version: 1.0	
	Date: 2005-11-13	

Test Case ID	TCT_013_01	
Test Case Name	Change in TCT, timeslot_payload_type, two ATM cells	
EN 301790 Reference	8.3.1.3, 8.5.5.4	
Objective / Test Purpose	Verify the correct reception and interpretation of the RCST when ATM traffic with two ATM cells is signalled via "timeslot_payload_type" in TCT for TRF bursts.	
Applicability / PICS	Only for ATM Profiles	
Initial RCST State	Off/Stand-by	
Expected Final RCST State	Fine sync state	
Test Method	Step	Description
	1	Test system is signalling TRF with two ATM cells in TCT. Timeslot type value 0x02
	2	Start RCST logon procedure
	3	Initiate IP traffic from Host PC at RCST side
	4	Test system verifies correct RCST's TRF burst composition Test system verifies RCST's transmit activities. Test system verifies that the RCST is only transmitting in allocated timeslots.
PASS/FAIL Criteria	<ul style="list-style-type: none"> <li>• Test procedure is fulfilled.</li> <li>• RCST is correctly assembling TRF slots in step 4</li> <li>• (two ATM cells).</li> </ul>	
Remarks		

<b>Implementation of the Common Test House for DVB-RCS Terminals</b>	Doc. No: T3-061-v1	
<b>ESA Contract No: 16878/02/NL/US</b>	Version: 1.0	
	Date: 2005-11-13	

Test Case ID	TCT_014_01	
Test Case Name	Change in TCT, timeslot_payload_type, four ATM cells	
EN 301790 Reference	8.3.1.3, 8.5.5.4	
Objective / Test Purpose	Verify the correct reception and interpretation of the RCST when ATM traffic with four ATM cells is signalled via "timeslot_payload_type" in TCT for TRF bursts.	
Applicability / PICS	Only for ATM Profiles	
Initial RCST State	Off/Stand-by	
Expected Final RCST State	Fine sync state	
Test Method	Step	Description
	1	Test system is signalling TRF with four ATM cells in TCT. Timeslot type value 0x04
	2	Start RCST logon procedure
	3	Initiate IP traffic from Host PC at RCST side
	4	Test system verifies correct RCST's TRF burst composition Test system verifies RCST's transmit activities. Test system verifies that the RCST is only transmitting in allocated timeslots.
PASS/FAIL Criteria	<ul style="list-style-type: none"> <li>• Test procedure is fulfilled.</li> <li>• RCST is correctly assembling TRF slots in step 4</li> <li>• (four ATM cells).</li> </ul>	
Remarks		

<b>Implementation of the Common Test House for DVB-RCS Terminals</b>	Doc. No: T3-061-v1	
<b>ESA Contract No: 16878/02/NL/US</b>	Version: 1.0	
	Date: 2005-11-13	

Test Case ID	TCT_015_01	
Test Case Name	Change in TCT, timeslot_payload_type, MPEG traffic	
EN 301790 Reference	8.3.1.3, 8.5.5.4	
Objective / Test Purpose	Verify the correct reception and interpretation of the RCST when MPEG traffic is signalled via "timeslot_payload_type" in TCT for TRF bursts.	
Applicability / PICS	MPEG_TRF	
Initial RCST State	Off/Stand-by	
Expected Final RCST State	Fine sync state	
Test Method	Step	Description
	1	Test system is signalling TRF with MPEG2-TS packets in TCT. Timeslot type value 0x05
	2	Start RCST logon procedure
	3	Initiate IP traffic from Host PC at RCST side
	4	Test system verifies correct RCST's TRF burst composition. Test system verifies RCST's transmit activities. Test system verifies that the RCST is only transmitting in allocated timeslots.
PASS/FAIL Criteria	<ul style="list-style-type: none"> <li>• Test procedure is fulfilled.</li> <li>• RCST is correctly assembling TRF slots in step 4</li> <li>• (MPEG2-TS packets).</li> </ul>	
Remarks		

<b>Implementation of the Common Test House for DVB-RCS Terminals</b>	Doc. No: T3-061-v1	
<b>ESA Contract No: 16878/02/NL/US</b>	Version: 1.0	
	Date: 2005-11-13	

Test Case ID	TCT_016_01	
Test Case Name	Change in TCT, symbol_rate; CSC, ACQ, SYNC	
EN 301790 Reference	8.3.1.3, 8.5.5.4	
Objective / Test Purpose	Verify the correct reception and interpretation of the RCST when in the TCT the value of "symbol_rate" has changed from the default value to the upper and lower edge value for CSC, ACQ and SYNC bursts.	
Applicability / PICS	-	
Initial RCST State	Off/Stand-by	
Expected Final RCST State	Off/Stand-by	
Test Method	Step	Description
	1	Test system transmits TCT with default value for symbol_rate
	2	Start RCST logon procedure
	3	Test system verifies correct CSC, ACQ and SYNC burst composition.
	4	Test system initiates RCST logoff
	5	Test system changes the symbol_rate and distributes the new value in TCT
	6	Proceed with step 2 until procedure is done for all values for the symbol rate that are specified for SatLabs terminals
	7	End
PASS/FAIL Criteria	<ul style="list-style-type: none"> <li>• Test procedure is fulfilled</li> <li>• RCST uses correct symbol_rate in step 3</li> </ul>	
Remarks	This test case will be available in 2 different versions. In the standard definition the symbol rate of the SYNC and TRF bursts will be equal (fixed MF-TDMA is mandatory). In a second version the symbol rate of the SYNC, ACQ and CSC are equal but different to the symbol rate of the TRF slots (used for optional dynamic MF-TDMA)	

<b>Implementation of the Common Test House for DVB-RCS Terminals</b> <b>ESA Contract No: 16878/02/NL/US</b>	Doc. No: T3-061-v1 Version: 1.0 Date: 2005-11-13	
--	--	---

Test Case ID	TCT_017_01	
Test Case Name	Change in TCT, symbol_rate; TRF	
EN 301790 Reference	8.3.1.3, 8.5.5.4	
Objective / Test Purpose	Verify the correct reception and interpretation of the RCST when in the TCT the value of "symbol_rate" has changed from the default value to the upper and lower edge value for TRF bursts.	
Applicability / PICS	-	
Initial RCST State	Off/Stand-by	
Expected Final RCST State	Off/Stand-by	
Test Method	Step	Description
	1	Test system transmits TCT with default value for symbol_rate
	2	Start RCST logon procedure
	3	Initiate IP traffic from Host PC at RCST side
	4	Test system verifies RCST's symbol rate for TRF bursts. Test system verifies RCST's transmit activities. Test system verifies that the RCST is only transmitting in allocated timeslots.
	5	Test System initiates RCST logoff
	6	Test system changes symbol_rate and distributes the new value in TCT
	7	Proceed with step 2 until procedure is done for all values for the symbol_rate that are specified for SatLabs terminals
	8	End
PASS/FAIL Criteria	<ul style="list-style-type: none"> <li>• Test procedure is fulfilled.</li> <li>• RCST uses correct symbol_rate in step 4.</li> <li>• Traffic is transported in step 4</li> </ul>	
Remarks	This test case will be available in 2 different versions. In the standard definition the symbol rate of the SYNC and TRF bursts will be equal (fixed MF-TDMA is mandatory). In a second version the symbol rate of the SYNC, ACQ and CSC are equal but different to the symbol rate of the TRF slots (used for optional dynamic MF-TDMA)	



Test Case ID	TCT_018_01	
Test Case Name	Change in TCT, Preamble_composition; CSC, ACQ, SYNC	
EN 301790 Reference	6.2.2.1, 6.2.2.2, 6.2.3, 8.3.1.3, 8.5.5.4	
Objective / Test Purpose	Verify the correct reception and interpretation of the RCST when in the TCT the value of "preamble_length" and "preamble_symbol" has changed from the default value for CSC, ACQ and SYNC bursts.	
Applicability / PICS	-	
Initial RCST State	Off/Stand-by	
Expected Final RCST State	Off/Stand-by	
Test Method	Step	Description
	1	Test system transmits TCT with default value for preamble_symbol and preamble_length
	2	Start RCST logon procedure
	3	Test system verifies correct CSC, ACQ and SYNC burst composition
	4	Test system initiates RCST logoff
	5	Test system changes preamble_length and composition of preamble_symbol for CSC, ACQ and SYNC and distributes the new values in TCT
	6	Proceed with step 2 until procedure is done for the minimum and the maximum preamble_length as specified for SatLabs terminals
	7	End
PASS/FAIL Criteria	<ul style="list-style-type: none"> <li>• Test procedure is fulfilled.</li> <li>• RCST is correctly assembling CSC, ACQ and SYNC bursts in step 3.</li> </ul>	
Remarks		

<b>Implementation of the Common Test House for DVB-RCS Terminals</b> <b>ESA Contract No: 16878/02/NL/US</b>	Doc. No: T3-061-v1 Version: 1.0 Date: 2005-11-13	
--	--	---

Test Case ID	TCT_019_01	
Test Case Name	Change in TCT, Preamble_composition; TRF with MPEG	
EN 301790 Reference	6.2.1.2, 8.3.1.3, 8.5.5.4	
Objective / Test Purpose	Verify the correct reception and interpretation of the RCST when in the TCT the value of "preamble_length" and "preamble_symbol" has changed from the default value for MPEG TRF bursts.	
Applicability / PICS	MPEG_TRF	
Initial RCST State	Off/Stand-by	
Expected Final RCST State	Off/Stand-by	
Test Method	Step	Description
	1	Test system transmits TCT with default value for preamble_length and preamble_symbol. Test system is signalling MPEG TRF as timeslot type in TCT.
	2	Start RCST logon procedure
	3	Initiate IP traffic from Host PC at RCST side
	4	Test system verifies assembling of RCST's TRF bursts Test system verifies RCST's transmit activities. Test system verifies that the RCST is only transmitting in allocated timeslots.
	5	Test system initiates RCST logoff
	6	Test system changes preamble_length and composition of preamble_symbol for TRF slots and distributes the new values in TCT
	7	Proceed with step 2 until procedure is done for the minimum and the maximum preamble_length as specified for SatLabs terminals
	8	End
PASS/FAIL Criteria	<ul style="list-style-type: none"> <li>• Test procedure is fulfilled.</li> <li>• RCST uses correctly assembled preambles in step 4.</li> <li>• Traffic is transported in step 4</li> </ul>	
Remarks		

<b>Implementation of the Common Test House for DVB-RCS Terminals</b>	Doc. No: T3-061-v1 Version: 1.0	
<b>ESA Contract No: 16878/02/NL/US</b>	Date: 2005-11-13	

Test Case ID	TCT_020_01	
Test Case Name	Change in TCT, Preamble_composition; TRF with ATM	
EN 301790 Reference	6.2.1.2, 8.3.1.3, 8.5.5.4	
Objective / Test Purpose	Verify the correct reception and interpretation of the RCST when in the TCT the value of "preamble_length" and "preamble_symbol" has changed from the default value for ATM TRF bursts.	
Applicability / PICS	-	
Initial RCST State	Off/Stand-by	
Expected Final RCST State	Off/Stand-by	
Test Method	Step	Description
	1	Test system transmits TCT with default value for preamble_length and preamble_symbol. Test system is signalling ATM TRF with default number of ATM cells as timeslot type in TCT.
	2	Start RCST logon procedure
	3	Initiate IP traffic from Host PC at RCST side
	4	Test system verifies assembling of RCST's TRF bursts Test system verifies RCST's transmit activities. Test system verifies that the RCST is only transmitting in allocated timeslots.
	5	Test system initiates RCST logoff
	6	Test system changes preamble_length and composition of preamble_symbol for TRF slots and distributes the new values in TCT
	7	Proceed with step 2 until procedure is done for the minimum and the maximum preamble_length as specified for SatLabs terminals
	8	End
PASS/FAIL Criteria	<ul style="list-style-type: none"> <li>• Test procedure is fulfilled.</li> <li>• RCST uses correctly assembled preambles in step 4.</li> <li>• Traffic is transported in step 4</li> </ul>	
Remarks		

Test Case ID	TCT_021_01	
Test Case Name	Change in TCT,Default permutation, Turbo code, CSC, SYNC	
EN 301790 Reference	8.5.5.4, 6.4.4.1 table5	
Objective / Test Purpose	Verify the correct reception and interpretation of the RCST when in the TCT new permutation bit is set to 0 for CSC and SYNC bursts. All possible values for P0, P1, P2, P3 should be tested. Turbo code is used as inner code type	
Applicability / PICS	-	
Initial RCST State	Off/Stand-by	
Expected Final RCST State	Off/Stand-by	
Test Method	Step	Description
	1	Test system transmits TCT with new_permutation_bit set to 0. Test system is signalling turbo code as inner_code_type in TCT.
	2	Start RCST logon procedure
	3	Test system verifies correct CSC and SYNC burst composition.
	4	Test system initiates RCST logoff
	5	Test system changes composition of the SYNC slots wrt SAC length to enter a new default_permutation definition of Table 5 in EN 101 790.
	6	Proceed with step 2 until procedure is done all possible values for P0, P1, P2, P3, described in table 5 of the standard for SYNC bursts
	7	End
PASS/FAIL Criteria	<ul style="list-style-type: none"> <li>• Test procedure is fulfilled</li> <li>• RCST is correctly coding CSC and SYNC bursts in step 3</li> </ul>	
Remarks	This test case also tests implicitly, whether the terminal supports different SAC field lengths in SYNC bursts.	

Test Case ID	TCT_022_01	
Test Case Name	Change in TCT, Default permutation, Turbo code, TRF	
EN 301790 Reference	8.5.5.4, 6.4.4.1 table5	
Objective / Test Purpose	Verify the correct reception and interpretation of the RCST when in the TCT new permutation bit is set to 0 for TRF bursts. All possible values for P0, P1, P2, P3 should be tested. Turbo code is used as inner code type	
Applicability / PICS	-	
Initial RCST State	Off/Stand-by	
Expected Final RCST State	Off/Stand-by	
Test Method	Step	Description
	1	Test system transmits TCT with new_permutation_bit set to 0. Test system is signalling turbo code as inner_code_type in TCT.
	2	Start RCST logon procedure
	3	Initiate IP traffic from Host PC at RCST side
	4	Test system verifies correct TRF burst composition. Test system verifies RCST's transmit activities. Test system verifies that the RCST is only transmitting in allocated timeslots.
	5	Test system initiates RCST logoff
	6	Test system changes composition of the TRF slots wrt the data content volume (type of TRF slot as applicable) and SAC length to enter a new default_permutation definition of Table 5 in EN 101 790.
	7	Proceed with step 2 until procedure is done all possible values for P0, P1, P2, P3, described in table 5 of the standard for TRF bursts
	8	End
PASS/FAIL Criteria	<ul style="list-style-type: none"> <li>• Test procedure is fulfilled.</li> <li>• RCST is correctly coding TRF bursts in step 4.</li> </ul>	
Remarks	<p>In this test case only those settings for the TRF bursts are applicable that are mandatory for the tested profile. This test case implicitly tests also the terminals ability to handle different SAC field lengths in the prefix of ATM bursts.</p>	

<b>Implementation of the Common Test House for DVB-RCS Terminals</b>	Doc. No: T3-061-v1	
<b>ESA Contract No: 16878/02/NL/US</b>	Version: 1.0	
	Date: 2005-11-13	

Test Case ID	TCT_023_01	
Test Case Name	Change in TCT, Route_ID	
EN 301790 Reference	8.5.5.4, 8.5.5.10.17	
Objective / Test Purpose	Verify that if in the TCT the Route_ID_flag set to '0' and the Return Interaction Path descriptor contains a Route_ID, the RCST transmits in the SAC field of the ATM prefix this Route_ID.	
Applicability / PICS	ROUTE_ID	
Initial RCST State	Off/Stand-by	
Expected Final RCST State	Fine sync state	
Test Method	Step	Description
	1	Test system transmits TCT with the Route_ID_flag set to '0' . Test system is signalling ATM TRF with default number of ATM cells as timeslot type in TCT.
	2	Start RCST logon procedure
	3	Initiate IP traffic from Host PC at RCST side
	4	Test system transmits Route_ID in the Return Interaction Path descriptor
	5	Test system verifies that the RCST correctly transmits Route_ID in the SAC field of the ATM prefix
PASS/FAIL Criteria	<ul style="list-style-type: none"> <li>• Test procedure is fulfilled</li> <li>• Traffic related to the correct Route-ID (correctly formatted SAC containing the Route-ID) achieved in step 5</li> </ul>	
Remarks		

This section consists of 43 single test cases, of which 4 are allocated to Concatenated Coding Combinations:

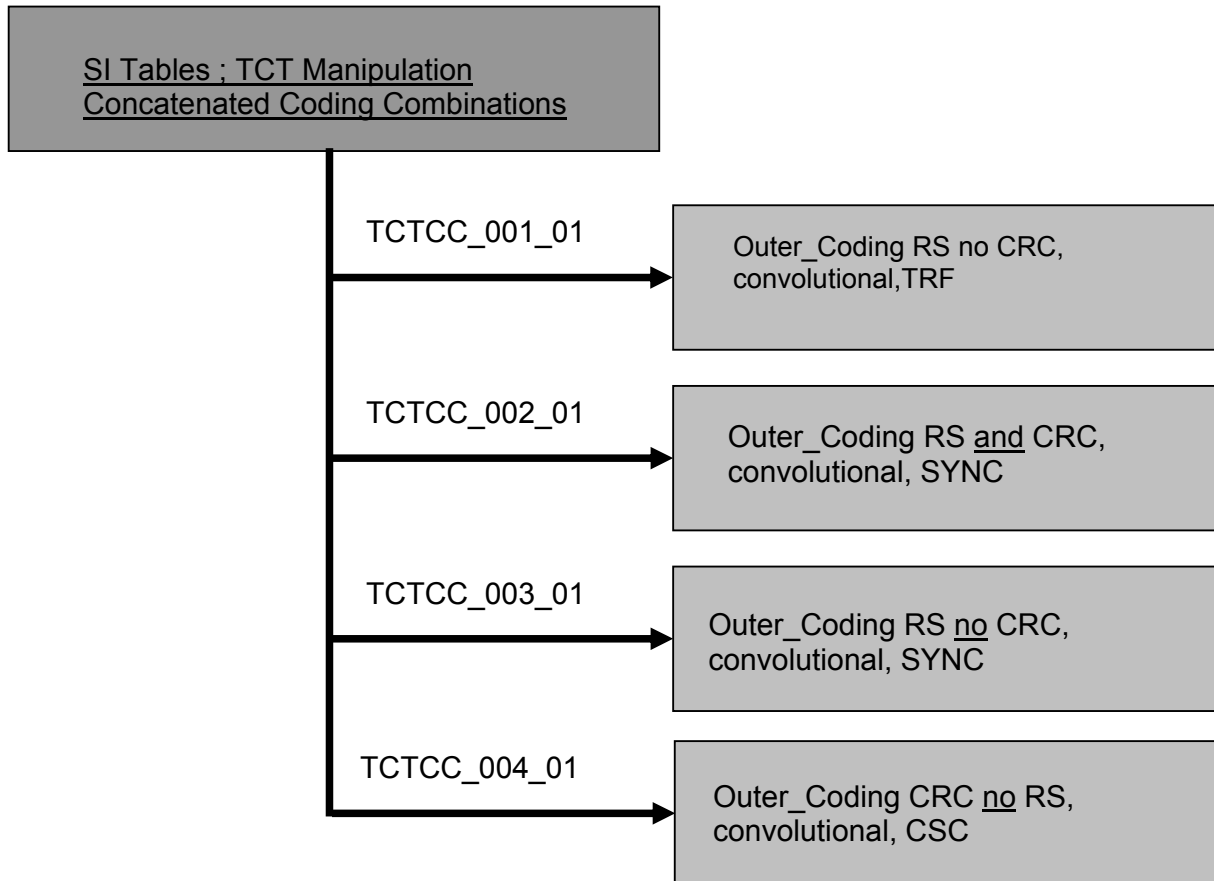

Test Case ID	TCTCC_001_01	
Test Case Name	Change in TCT, Outer_Coding RS no CRC, convolutional, TRF	
EN 301790 Reference	8.5.5.4, TR101790 6.4.5.1	
Objective / Test Purpose	Verify the correct reception and interpretation of the RCST when in the TCT RS, no CRC as outer coding mode is signaled for TRF bursts. Convolutional code is used as inner code type. The symbol- and code rate should not vary during test.	
Applicability / PICS	CONV_RS	
Initial RCST State	Off/Stand-by	
Expected Final RCST State	Fine sync state	
Test Method	Step	Description
	1	Test system is signalling RS, no CRC as outer_coding mode for TRF bursts in TCT, outer_coding value=01. Convolutional code is used as inner_code_type
	2	Start RCST logon procedure
	3	Initiate IP traffic from Host PC at RCST side
	4	Test system verifies correct RCST's TRF burst coding. Test system verifies RCST's transmit activities. Test system verifies that the RCST is only transmitting in allocated timeslots.
PASS/FAIL Criteria	<ul style="list-style-type: none"> <li>• Test procedure is fulfilled</li> <li>• RCST is correctly coding TRF bursts in step 4.</li> </ul>	
Remarks		



<b>Implementation of the Common Test House for DVB-RCS Terminals</b>	Doc. No: T3-061-v1	
<b>ESA Contract No: 16878/02/NL/US</b>	Version: 1.0	
	Date: 2005-11-13	

Test Case ID	TCTCC_002_01	
Test Case Name	Change in TCT, Outer_Coding RS <u>and</u> CRC, convolutional, SYNC	
EN 301790 Reference	8.5.5.4, TR101790 6.4.5.1	
Objective / Test Purpose	Verify the correct reception and interpretation of the RCST when in the TCT RS <u>and</u> CRC as outer coding mode is signaled for SYNC bursts. Convolutional code is used as inner code type. The symbol- and code rate should not vary during test.	
Applicability / PICS	CONV_RS	
Initial RCST State	Off/Stand-by	
Expected Final RCST State	Fine sync state	
Test Method	Step	Description
	1	Test system is signalling RS and CRC as outer_coding mode for SYNC bursts in TCT, outer_coding value = 00. Convolutional code is used as inner_code_type
	2	Start RCST logon procedure
	3	Test system verifies correct coding of SYNC bursts.
PASS/FAIL Criteria	<ul style="list-style-type: none"> <li>• Test procedure is fulfilled.</li> <li>• RCST is correctly coding SYNC bursts in step 3.</li> </ul>	
Remarks		

Test Case ID	TCTCC_003_01	
Test Case Name	Change in TCT, Outer_Coding RS <u>no</u> CRC, convolutional, SYNC	
EN 301790 Reference	8.5.5.4, TR101790 6.4.5.1	
Objective / Test Purpose	Verify the correct reception and interpretation of the RCST when in the TCT RS, <u>no</u> CRC as outer coding mode is signaled for SYNC bursts. Convolutional code is used as inner code type. The symbol- and code rate should not vary during test.	
Applicability / PICS	CONV_RS	
Initial RCST State	Off/Stand-by	
Expected Final RCST State	Fine sync state	
Test Method	Step	Description
	1	Test system is signalling RS no CRC as outer_coding mode for SYNC bursts in TCT, outer_coding value = 01. Convolutional code is used as inner_code_type
	2	Start RCST logon procedure
	3	Test system verifies correct coding of SYNC bursts.
PASS/FAIL Criteria	<ul style="list-style-type: none"> <li>• Test procedure is fulfilled.</li> <li>• RCST is correctly coding SYNC bursts in step 3.</li> </ul>	
Remarks		

<b>Implementation of the Common Test House for DVB-RCS Terminals</b>	Doc. No: T3-061-v1	
<b>ESA Contract No: 16878/02/NL/US</b>	Version: 1.0	
	Date: 2005-11-13	

Test Case ID	TCTCC_004_01	
Test Case Name	Change in TCT, Outer_Coding CRC <u>no</u> RS, convolutional, CSC	
EN 301790 Reference	8.5.5.4, TR101790 6.4.5.1	
Objective / Test Purpose	Verify the correct reception and interpretation of the RCST when in the TCT CRC, <u>no</u> RS as outer coding mode is signaled for CSC bursts. Convolutional code is used as inner code type. The symbol- and code rate should not vary during test.	
Applicability / PICS	CONV_RS	
Initial RCST State	Off/Stand-by	
Expected Final RCST State	Fine sync state	
Test Method	Step	Description
	1	Test system is signalling CRC no RS as outer_coding mode in TCT for CSC bursts, outer_coding value = 10. Convolutional code is used as inner_code_type
	2	Start RCST logon procedure
	3	Test system verifies correct coding of CSC bursts.
PASS/FAIL Criteria	<ul style="list-style-type: none"> <li>• Test procedure is fulfilled</li> <li>• RCST is correctly coding CSC bursts in step 3.</li> </ul>	
Remarks		

This section consists of 43 single test cases, of which 4 are allocated to Turbo Coding Combinations:

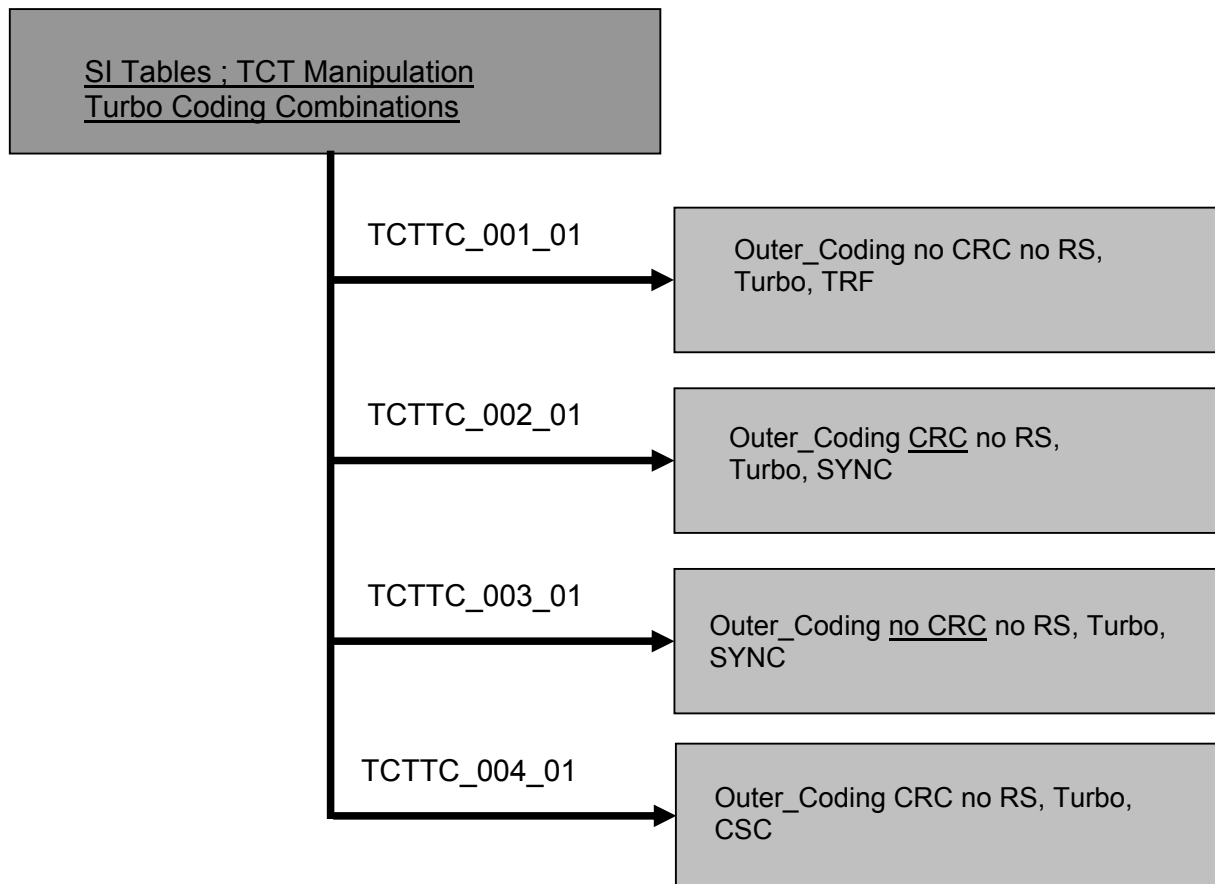

Test Case ID	TCTTC_001_01	
Test Case Name	Change in TCT, Outer_Coding no CRC no RS, Turbo, TRF	
EN 301790 Reference	8.5.5.4, TR101790 6.4.5.2	
Objective / Test Purpose	Verify the correct reception and interpretation of the RCST when in the TCT no RS, no CRC as outer coding mode is signaled for TRF bursts. Turbo code is used as inner code type. The symbol- and code rate should not vary during test.	
Applicability / PICS	-	
Initial RCST State	Off/Stand-by	
Expected Final RCST State	Fine sync state	
Test Method	Step	Description
	1	Test system is signalling no RS, no CRC as outer_coding mode for TRF bursts in TCT, outer_coding value = 11. Turbo code is used as inner_code_type
	2	Start RCST logon procedure
	3	Initiate IP traffic from Host PC at RCST side
	4	Test system verifies correct RCST's TRF burst coding. Test system verifies RCST's transmit activities. Test system verifies that the RCST is only transmitting in allocated timeslots.
PASS/FAIL Criteria	<ul style="list-style-type: none"> <li>• Test procedure is fulfilled.</li> <li>• RCST is correctly coding TRF bursts in step 4.</li> </ul>	
Remarks		

<b>Implementation of the Common Test House for DVB-RCS Terminals</b>	Doc. No: T3-061-v1	
<b>ESA Contract No: 16878/02/NL/US</b>	Version: 1.0	
	Date: 2005-11-13	

Test Case ID	TCTTC_002_01	
Test Case Name	Change in TCT, Outer_Coding_CRC no RS, Turbo, SYNC	
EN 301790 Reference	8.5.5.4, TR101790 6.4.5.2	
Objective / Test Purpose	Verify the correct reception and interpretation of the RCST when in the TCT no RS, CRC as outer coding mode is signaled for SYNC bursts. Turbo code is used as inner code type. The symbol- and code rate should not vary during test.	
Applicability / PICS	Optional; only used for terminals using Contention based mini-slot method	
Initial RCST State	Off/Stand-by	
Expected Final RCST State	Fine sync state	
Test Method	Step	Description
	1	Test system is signalling CRC no RS as outer_coding mode for SYNC bursts in TCT, outer_coding value = 10. Turbo code is used as inner_code_type
	2	Start RCST logon procedure
	3	Test system verifies correct coding of SYNC bursts.
PASS/FAIL Criteria	<ul style="list-style-type: none"> <li>• Test procedure is fulfilled.</li> <li>• RCST is correctly coding SYNC bursts in step 3.</li> </ul>	
Remarks	Test case has been classified as optional test. This test case is only to be used in systems that are tested with contention based mini-slot method.	

<b>Implementation of the Common Test House for DVB-RCS Terminals</b>	Doc. No: T3-061-v1	
<b>ESA Contract No: 16878/02/NL/US</b>	Version: 1.0	
	Date: 2005-11-13	

Test Case ID	TCTTC_003_01	
Test Case Name	Change in TCT, Outer_Coding <u>no CRC</u> no RS, Turbo, SYNC	
EN 301790 Reference	8.5.5.4, TR101790 6.4.5.2	
Objective / Test Purpose	Verify the correct reception and interpretation of the RCST when in the TCT no RS, no CRC as outer coding mode is signaled for SYNC bursts. Turbo code is used as inner code type. The symbol- and code rate should not vary during test.	
Applicability / PICS	-	
Initial RCST State	Off/Stand-by	
Expected Final RCST State	Fine sync state	
Test Method	Step	Description
	1	Test system is signalling no CRC no RS as outer_coding mode for SYNC bursts in TCT, outer_coding value = 11. Turbo code is used as inner_code_type
	2	Start RCST logon procedure
	3	Test system verifies correct coding of SYNC bursts
PASS/FAIL Criteria	<ul style="list-style-type: none"> <li>• Test procedure is fulfilled</li> <li>• RCST is correctly coding SYNC bursts in step 3.</li> </ul>	
Remarks		

Test Case ID	TCTTC_004_01	
Test Case Name	Change in TCT, Outer_Coding CRC no RS, Turbo, CSC	
EN 301790 Reference	8.5.5.4, TR101790 6.4.5.2	
Objective / Test Purpose	Verify the correct reception and interpretation of the RCST when in the TCT no RS, CRC as outer coding mode is signaled for CSC bursts. Turbo code is used as inner code type. The symbol- and code rate should not vary during test.	
Applicability / PICS	-	
Initial RCST State	Off/Stand-by	
Expected Final RCST State	Fine sync state	
Test Method	Step	Description
	1	Test system is signalling CRC no RS as outer_coding mode in TCT for CSC bursts, outer_coding value = 10. Turbo code is used as inner_code_type
	2	Start RCST logon procedure
	3	Test system verifies correct coding of CSC bursts.
PASS/FAIL Criteria	<ul style="list-style-type: none"> <li>• Test procedure is fulfilled</li> <li>• RCST is correctly coding CSC bursts in step 3.</li> </ul>	
Remarks		



This section consists of 43 single test cases, of which 4 are allocated to Interoperability:

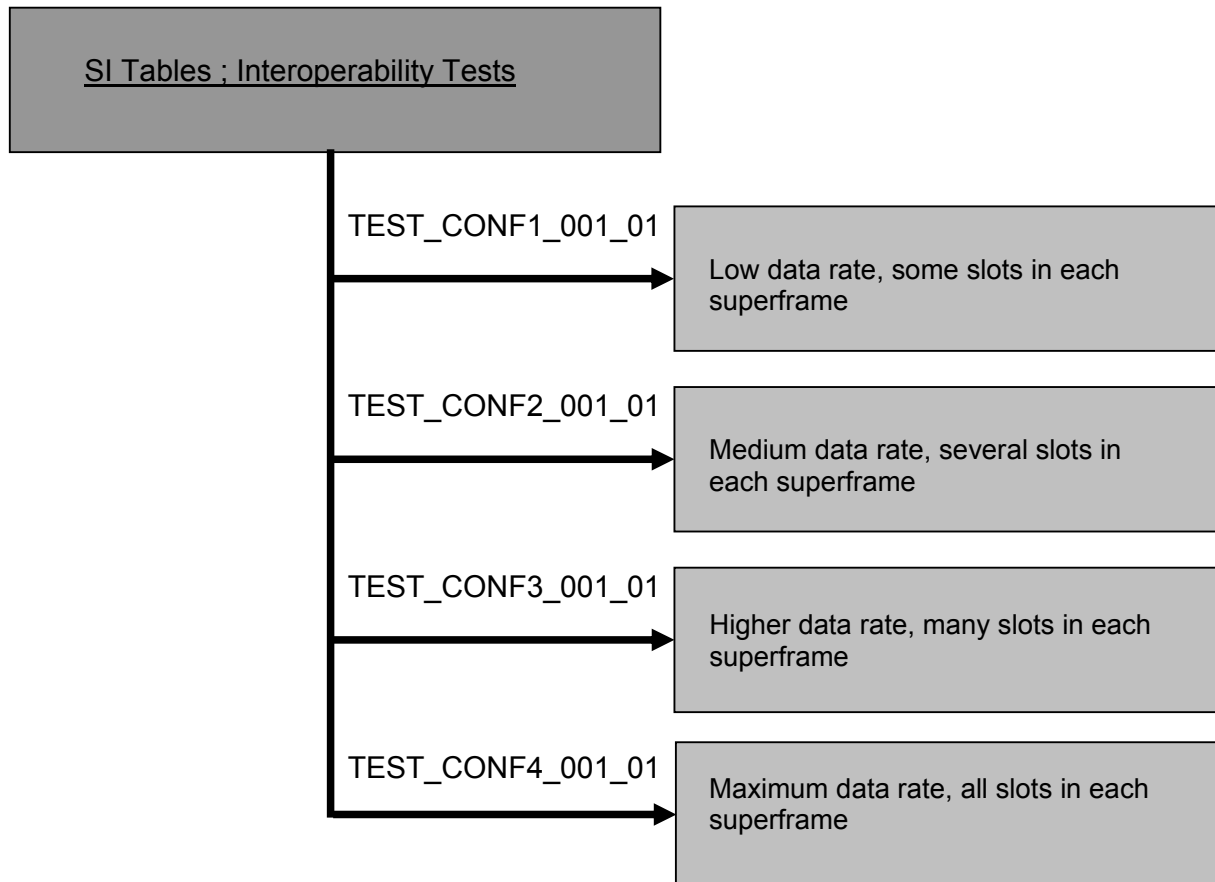

<b>Implementation of the Common Test House for DVB-RCS Terminals</b>	Doc. No: T3-061-v1	
<b>ESA Contract No: 16878/02/NL/US</b>	Version: 1.0	
	Date: 2005-11-13	

Test Case ID	TEST_CONF1_001_01	
Test Case Name	Low data rate, some slots in each superframe	
EN 301790 Reference	8.5.5.2, 8.5.5.3, 8.5.5.4, 8.5.5.7	
Objective / Test Purpose	Verify correct RCST logon and IP traffic in both directions if only few slots are allocated per frame, allowing a capacity of 128 kbit/s to be transported	
Applicability / PICS	-	
Initial RCST State	Off/Stand-by	
Expected Final RCST State	Fine sync state	
Test Method	Step	Description
	1	Test system is signalling all tables using default settings as specified in SatLabs
	2	Start RCST logon procedure
	3	Test system verifies correct coding of CSC bursts.
	4	RCST has reached the Fine Sync state
	5	Initiate IP traffic 128 kbit/s data rate from RCST side
	6	Test system allocates sufficient TRF timeslots for the terminal to transmit up to 128 kbit/s of user data (net rate)
	7	TS verifies error-free reception of IP packets;
	8	TS initiates IP traffic to RCST at 128 kbit/s data rate
	9	TS verifies error-free reception of IP packets
PASS/FAIL Criteria	<ul style="list-style-type: none"> <li>• Test procedure is fulfilled.</li> <li>• Error-free transmission of IP payload in step 7 and step 9; Usual error occurrences as they must be expected in usual UDP/TCP transmission shall not be deemed as fail criteria for the terminal.</li> </ul>	
Remarks		

<b>Implementation of the Common Test House for DVB-RCS Terminals</b>	Doc. No: T3-061-v1	
<b>ESA Contract No: 16878/02/NL/US</b>	Version: 1.0	
	Date: 2005-11-13	

Test Case ID	TEST_CONF2_001_01	
Test Case Name	Medium data rate, several slots in each superframe	
EN 301790 Reference	8.5.5.2, 8.5.5.3, 8.5.5.4, 8.5.5.7	
Objective / Test Purpose	Verify correct RCST logon and IP traffic in both directions if several slots are allocated per frame allowing a capacity of 256 kbit/s to be transported	
Applicability / PICS	-	
Initial RCST State	Off/Stand-by	
Expected Final RCST State	Fine sync state	
Test Method	Step	Description
	1	Test system is signalling all tables using default settings as specified in SatLabs
	2	Start RCST logon procedure
	3	Test system verifies correct coding of CSC bursts.
	4	RCST has reached the Fine Sync state
	5	Initiate IP traffic 256 kbit/s data rate from RCST side
	6	Test system allocates sufficient TRF timeslots for the terminal to transmit up to 256 kbit/s of user data (net rate)
	7	TS verifies error-free reception of IP packets;
	8	TS initiates IP traffic to RCST at 256 kbit/s data rate
	9	TS verifies error-free reception of IP packets
PASS/FAIL Criteria	<ul style="list-style-type: none"> <li>• Test procedure is fulfilled.</li> <li>• Error-free transmission of IP payload in step 7 and step 9; Usual error occurrences as they must be expected in usual UDP/TCP transmission shall not be deemed as fail criteria for the terminal.</li> </ul>	
Remarks		

Test Case ID	TEST_CONF3_001_01	
Test Case Name	Higher data rate, many slots in each superframe	
EN 301790 Reference	8.5.5.2, 8.5.5.3, 8.5.5.4, 8.5.5.7	
Objective / Test Purpose	Verify correct RCST logon and IP traffic in both directions if many slots are allocated per frame allowing a capacity of 512 kbit/s to be transported	
Applicability / PICS	-	
Initial RCST State	Off/Stand-by	
Expected Final RCST State	Fine sync state	
Test Method	Step	Description
	1	Test system is signalling all tables using a frame/superframe composition which is better optimized for high data rates (compared to the default settings)
	2	Start RCST logon procedure
	3	Test system verifies correct coding of CSC bursts.
	4	RCST has reached the Fine Sync state
	5	Initiate IP traffic 512 kbit/s data rate from RCST side
	6	Test system allocates sufficient TRF timeslots for the terminal to transmit up to 512 kbit/s of user data (net rate)
	7	TS verifies error-free reception of IP packets;
	8	TS initiates IP traffic to RCST at 512 kbit/s data rate
	9	TS verifies error-free reception of IP packets
PASS/FAIL Criteria	<ul style="list-style-type: none"> <li>• Test procedure is fulfilled.</li> <li>• Error-free transmission of IP payload in step 7 and step 9; Usual error occurrences as they must be expected in usual UDP/TCP transmission shall not be deemed as fail criteria for the terminal.</li> </ul>	
Remarks		

Test Case ID	TEST_CONF4_001_01	
Test Case Name	Maximum data rate, all slots in each superframe	
EN 301790 Reference	8.5.5.2, 8.5.5.3, 8.5.5.4, 8.5.5.7	
Objective / Test Purpose	Verify correct RCST logon and IP traffic in both directions if all TRF slots are allocated to the terminal allowing a maximum capacity to be transported	
Applicability / PICS	-	
Initial RCST State	Off/Stand-by	
Expected Final RCST State	Fine sync state	
Test Method	Step	Description
	1	Test system is signalling all tables using a frame/superframe composition which is better optimized for high data rates (compared to the default settings)
	2	Start RCST logon procedure
	3	Test system verifies correct coding of CSC bursts.
	4	RCST has reached the Fine Sync state
	5	Initiate IP traffic at maximum possible data rate from RCST side
	6	Test system allocates all TRF timeslots for the terminal to transmit at maximum possible rate of user data (net rate)
	7	TS verifies error-free reception of IP packets;
	8	TS initiates IP traffic to RCST at the same data rate as reached in step 6.
	9	TS verifies error-free reception of IP packets
PASS/FAIL Criteria	<ul style="list-style-type: none"> <li>• Test procedure is fulfilled.</li> <li>• Error-free transmission of IP payload in step 7 and step 9; Usual error occurrences as they must be expected in usual UDP/TCP transmission shall not be deemed as fail criteria for the terminal.</li> </ul>	
Remarks		

### 9.13 Frequency Hopping

This section verifies that the terminal is capable of performing frequency hopping as defined in ETSI EN 301 790 V1.3.1. Furthermore it is verified, whether the given frequency hopping ranges are implemented properly.

#### Reason for having this test

To optimally use the available capacity in the return channel, the RCST must be capable of changing the burst center frequency from burst to burst. When this frequency hopping is not working accurately signal conflicts in the return channel cannot be avoided.

**This section consists of 3 single test cases:**

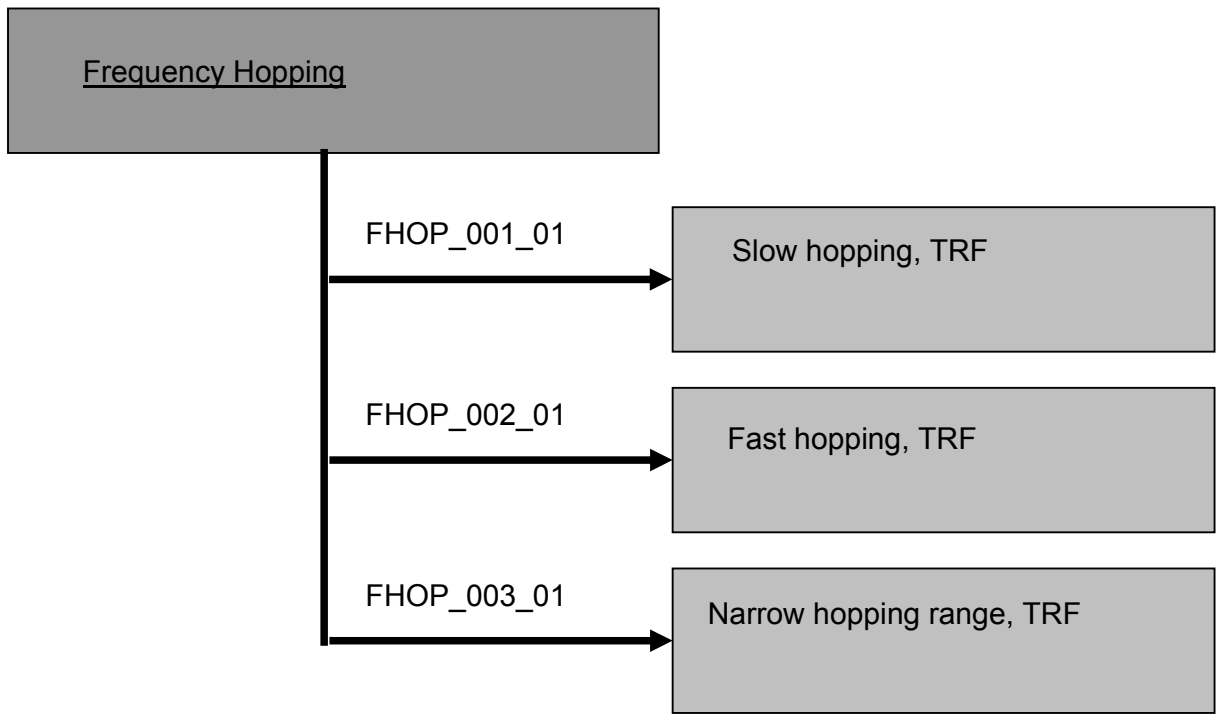

Test Case ID	FHOP_001_01	
Test Case Name	Change in TBTP; slow hopping; TRF	
EN 301790 Reference	6.2.3; 8.5.5.7; 6.7	
Objective / Test Purpose	Testsystem allocates TRF slots to RCST with TBTP in a way that there is <u>an</u> additional TRF slot between transmissions on different carrier frequencies. The correct RCST transmission in allocated TRF slots is verified.	
Applicability / PICS	-	
Initial RCST State	Receive sync state	
Expected Final RCST State	Fine sync state	
Test Method	Step	Description
	1	Start RCST logon procedure
	2	Initiate IP traffic from Host PC at RCST side
	3	Test system allocates TRF slots to RCST with TBTP in a way that there is <u>an</u> additional TRF slot between transmissions on different carrier frequencies
	4	Test system verifies RCST`s transmit activities. Test system verifies that the RCST is transmitting in the majority of the allocated timeslots (see Remark).
	5	Repeat step 3 to step 4 for at least 3 minutes.
PASS/FAIL Criteria	<ul style="list-style-type: none"> <li>• Test procedure is fulfilled.</li> <li>• RCST does not leave fine sync state in step 3 or step 4 .</li> <li>• Expected time and frequency position of the bursts (within SYNC thresholds) in step 4</li> <li>• RCST uses the allocated timeslots to a high extent (see Remark)</li> </ul>	
Remarks	According to the understanding which was found in SatLabs the terminal is responsible for deciding if it can guarantee enough stability and accuracy to use a certain allocated timeslot. It might occur that a terminal does not use all the allocated slots, however, the test case shall show that a terminal supporting slow_hopping (mandatory) is using the majority of the allocated timeslots.	

Test Case ID	FHOP_002_01	
Test Case Name	Change in TBTP; fast hopping; TRF	
EN 301790 Reference	6.2.3; 8.5.5.7; 6.7	
Objective / Test Purpose	Testsystem allocates TRF slots to RCST with TBTP in a way that there is <u>no</u> additional TRF slot between transmissions on different carrier frequencies. The correct RCST transmission in allocated TRF slots is verified.	
Applicability / PICS	FAST_HOPP	
Initial RCST State	Receive sync state	
Expected Final RCST State	Fine sync state	
Test Method	Step	Description
	1	Start RCST logon procedure
	2	Initiate IP traffic from Host PC at RCST side
	3	Testsystem allocates TRF slots to RCST with TBTP in a way that there is <u>no</u> additional TRF slot between transmissions on different carrier frequencies
	4	Test system verifies RCST's transmit activities. Test system verifies that the RCST is transmitting in the majority of the allocated timeslots (see Remark).
	5	Repeat step 3 to step 4 for at least 3 minutes.
PASS/FAIL Criteria	<ul style="list-style-type: none"> <li>• Test procedure is fulfilled.</li> <li>• RCST does not leave fine sync state in step 3 or step 4</li> <li>• Expected time and frequency position of the bursts (within SYNC thresholds) in step 4</li> <li>• RCST uses the allocated timeslots to a high extent (see Remark)</li> </ul>	
Remarks	According to the understanding which was found in SatLabs the terminal is responsible for deciding if it can guarantee enough stability and accuracy to use a certain allocated timeslot. It might occur that a terminal does not use all the allocated slots, however, the test case shall show that a terminal supporting fast_hopping is using the majority of the allocated timeslots.	



Test Case ID	FHOP_003_01	
Test Case Name	Change in TBTP; narrow hopping range; TRF	
EN 301790 Reference	6.2.3; 8.5.5.7; 6.7	
Objective / Test Purpose	Testsystem allocates TRF slots to RCST with TBTP in a way that the narrow hopping range of 20 MHz is covered. Fast/Slow-hopping capability of the RCST should be respected. The correct RCST transmission in allocated TRF slots is verified.	
Applicability / PICS	-	
Initial RCST State	Receive sync state	
Expected Final RCST State	Fine sync state	
Test Method	Step	Description
	1	Start RCST logon procedure
	2	Initiate IP traffic from Host PC at RCST side
	3	Test system allocates timeslots (frequency channels) to the RCST out of the narrow hopping range of 20 MHz. The frequency distribution of these allocated timeslots (frequency channels) should be random.
	4	Test system verifies RCST's transmit activities. Test system verifies that the RCST is transmitting in the majority of the allocated timeslots
	5	Repeat step 3 to step 4 for 3 minutes.
PASS/FAIL Criteria	<ul style="list-style-type: none"> <li>• Test procedure is fulfilled.</li> <li>• RCST does not leave fine sync state in step 3 or step 4</li> <li>• Expected time and frequency position of the bursts (within SYNC thresholds) in step 4</li> <li>• RCST uses the allocated timeslots to a high extent (see Remark)</li> </ul>	
Remarks	According to the understanding which was found in SatLabs the terminal is responsible for deciding if it can guarantee enough stability and accuracy to use a certain allocated timeslot. It might occur that a terminal does not use all the allocated slots, however, the test case shall show that a terminal supporting fast_hopping is using the majority of the allocated timeslots.	

### 9.14 Terminal Burst Time Plan

This section verifies, that the terminal is capable of accepting the right burst allocations which are transferred in the terminal burst time plan. The available assignment types are verified by allocating single time assignments as well as repeating assignments of bursts. Furthermore, it is verified whether the RCST is capable of handling all assignment count values from the expected minimum to the expected maximum.

#### Reason for having this test

The return channel forms a shared media channel, in which the multiple transmitters must be synchronised. The terminal burst time plan must be received and interpreted correctly by the RCST to ensure that there are no conflicts in the return channel.

**This section consists of 3 single test cases:**

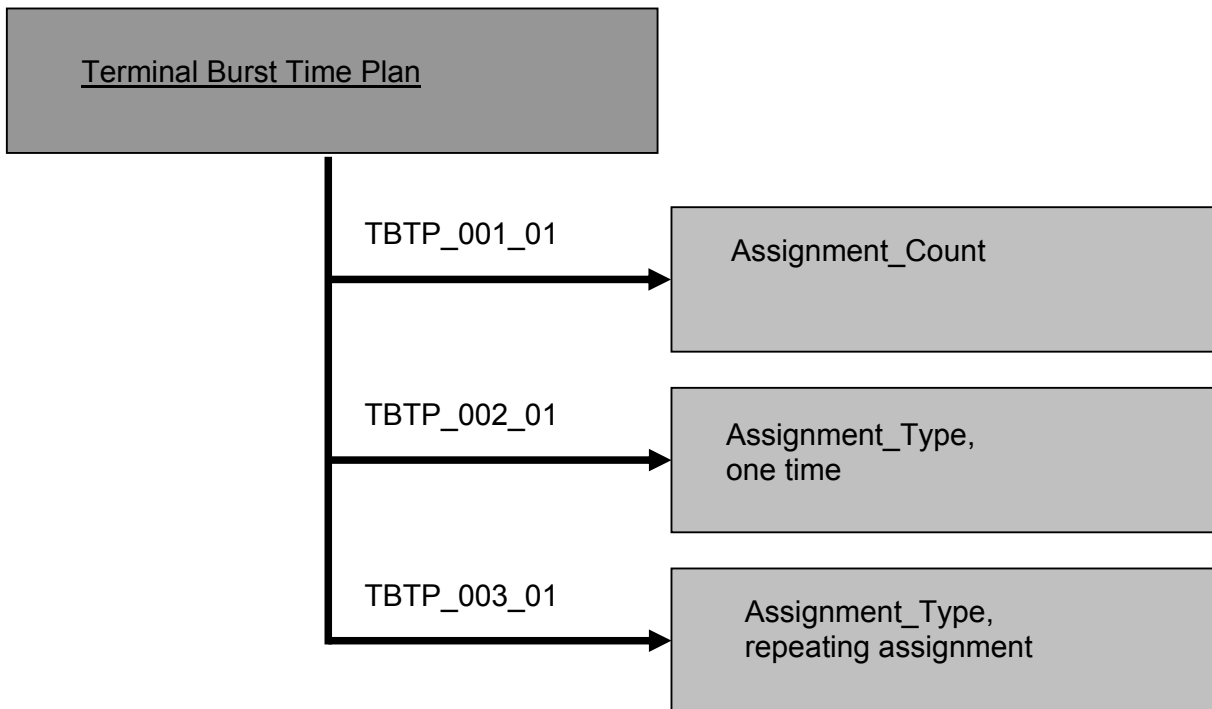

<b>Implementation of the Common Test House for DVB-RCS Terminals</b>	Doc. No: T3-061-v1 Version: 1.0	
<b>ESA Contract No: 16878/02/NL/US</b>	Date: 2005-11-13	

Test Case ID	TBTP_001_01	
Test Case Name	Change in TBTP; Assignment_Count	
EN 301790 Reference	8.3.1.6, 8.5.5.7	
Objective / Test Purpose	Verify the correct reception and interpretation of the RCST when in the TBTP the value of "Assignment_Count" is varied from min to max value. Only One-time assignment method will be tested.	
Applicability / PICS	-	
Initial RCST State	Receive sync state	
Expected Final RCST State	Fine sync state	
Test Method	Step	Description
	1	Start RCST logon procedure
	2	Initiate IP traffic from Host PC at RCST side
	3	Test system allocates TRF slots to the RCST with help of the TBTP, the value for assignment count is set to min value
	4	Test system verifies RCST's transmit activities. Test system verifies that the RCST is transmitting in each allocated timeslot
	5	Test system increases number of allocated TRF slots (assignment_count)
	6	Proceed with step 4 until value for assignment_count has reached max value
PASS/FAIL Criteria	<ul style="list-style-type: none"> <li>• Test procedure is fulfilled.</li> <li>• RCST is correctly transmitting in allocated timeslots, according to the "assignment_count", in step 4.</li> </ul>	
Remarks		

Test Case ID	TBTP_002_01	
Test Case Name	Change in TBTP; Assignment_Type; one time	
EN 301790 Reference	8.3.1.6, 8.5.5.7	
Objective / Test Purpose	Verify the correct reception and interpretation of the RCST when in the TBTP "one_time_assignment" is signalled as Assignment_Type for RCST.	
Applicability / PICS	-	
Initial RCST State	Receive sync state	
Expected Final RCST State	Fine sync state	
Test Method	Step	Description
	1	Start RCST logon procedure
	2	Initiate IP traffic from Host PC at RCST side
	3	Test system allocates TRF slots to the RCST with help of the TBTP, one time assignment is selected as assignment_type
	4	Test system verifies RCST's transmit activities. Test system verifies that the RCST is transmitting in each allocated timeslot
	5	Repeat step 3 to step 4 for 3 minutes
PASS/FAIL Criteria	<ul style="list-style-type: none"> <li>• Test procedure is fulfilled.</li> <li>• RCST is correctly transmitting in allocated timeslots, according to the "assignment_type", in step 4.</li> </ul>	
Remarks		

Test Case ID	TBTP_003_01	
Test Case Name	Change in TBTP; Assignment_Type; repeating assignment	
EN 301790 Reference	8.3.1.6, 8.5.5.7	
Objective / Test Purpose	Verify the correct reception and interpretation of the RCST when in the TBTP "repeating_assignment" is signalled as Assignment_Type for RCST.	
Applicability / PICS	-	
Initial RCST State	Receive sync state	
Expected Final RCST State	Fine sync state	
Test Method	Step	Description
	1	Start RCST logon procedure
	2	Initiate IP traffic from Host PC at RCST side
	3	Test system allocates TRF slots to the RCST with help of the TBTP, repeating assignment is selected as assignment_type
	4	Test system verifies RCST's transmit activities. Test system verifies that the RCST is transmitting in each allocated timeslot
	5	Repeat step 3 to step 4 for 10 minutes
PASS/FAIL Criteria	Test procedure is fulfilled. RCST is correctly transmitting in allocated timeslots, according to the "assignment_type", in step 4.	
Remarks	For the time being this test case is not performed as it has been decided not to use the repeated assignment due to some procedural uncertainties in this assignment method.	

### 9.15 Satellite Position Table

In this section the RCST's acceptance to changes in the SPT is verified.

#### Reason for having this section:

All timing of the return channel is dependent on the knowledge where the RCST and the satellite is positioned. A change in the position leads to a change in the signal latency (also seen as a phase shift). To enable a RCST to properly interwork in the network and to prevent any confusion on the return channel signal, RCST must be able to realise changes in its SPT configuration.

**This section consists of 1 single test case:**

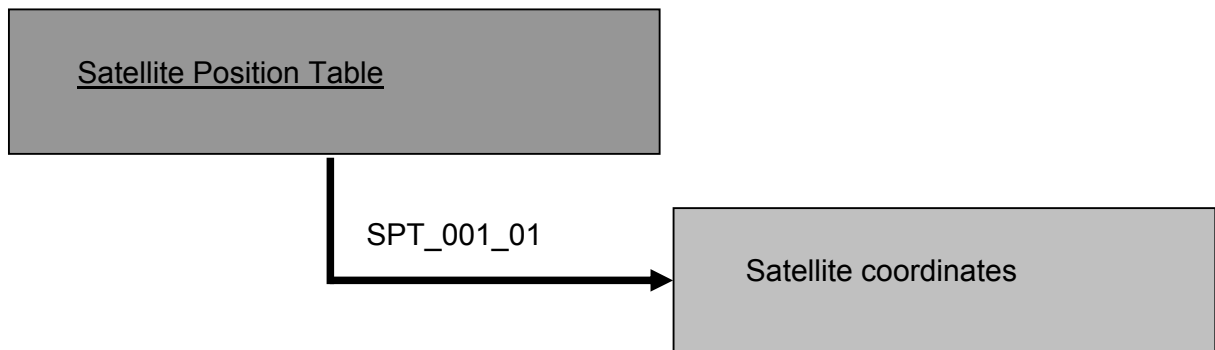

Test Case ID	SPT_001_01	
Test Case Name	Change in SPT; satellite coordinates	
EN 301790 Reference	8.3.1.4, 8.5.5.5, 6.1.3	
Objective / Test Purpose	Verify the correct reception and interpretation of the RCST when in the SPT the content of x,y and z coordinates has changed from default value.	
Applicability / PICS	-	
Initial RCST State	Off/Stand-by	
Expected Final RCST State	Off/Stand-by	
Test Method	Step	Description
	1	Set distance, represented by x,y,z coordinates in SPT table, to min value = distance_min The RCST shall use these coordinates (distances) to calculate the propagation delay between RCST and satellite
	2	Test system transmits SPT with distance_min
	3	Start RCST logon procedure
	4	Test system verifies that the timing of the CSC and SYNC bursts is as expected.
	5	Initiate IP traffic from Host PC at RCST side
	6	Test system verifies RCST's transmit activities. Test system verifies that the propagation delay is calculated correctly by verifying, that the TRF bursts are received in the expected burst window.
	7	Test system initiates RCST logoff
	8	Set X, Y, Z coordinates (distance) to max value = distance_max
	9	Repeat steps 2 through 7 with the new settings
10	End	
PASS/FAIL Criteria	<ul style="list-style-type: none"> <li>• Test procedure is fulfilled.</li> <li>• CSC and SYNC bursts are received in the expected burst window in step 4.</li> <li>• RCST has achieved fine sync state in step 4.</li> <li>• TRF bursts are received in the expected burst window in step 6.</li> </ul>	
Remarks		

### 9.16 Basic Application Testing

In this section the ability of the terminal is tested to correctly encapsulate IP datagrams and to transfer them in both directions.

#### Reason for having this test

The ability of IP datagram forwarding is a substantial user requirement on a DVB-RCS network. Although this functionality is not mentioned explicitly, the given applications form a basic requirement. Without having the possibility to send ICMP commands (Ping) network administration is nearly impossible.

This section consists of 2 single test cases:

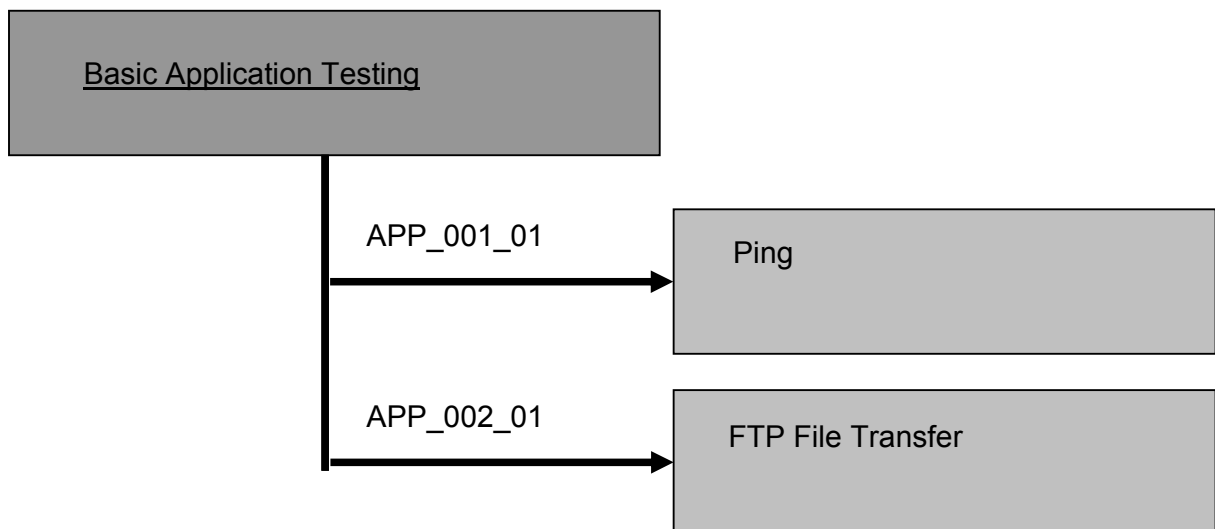



<b>Implementation of the Common Test House for DVB-RCS Terminals</b>	Doc. No: T3-061-v1	
<b>ESA Contract No: 16878/02/NL/US</b>	Version: 1.0	
	Date: 2005-11-13	

Test Case ID	APP_001_01	
Test Case Name	Ping	
EN 301790 Reference	8.1.1	
Objective / Test Purpose	Verify basic IP connectivity by performing ping in both directions	
Applicability / PICS		
Initial RCST State	Fine Sync state	
Expected Final RCST State	Fine Sync state	
Test Method	Step	Description
	1	Send PING from tester side to RCST for 10 minutes
	2	Verify response
	3	Send PING from RCST side to test system for 10 minutes
	4	Verify response
PASS/FAIL Criteria	<ul style="list-style-type: none"> <li>In step 2 and 4 all responses must be received within 1 second</li> </ul>	
Remarks		

<b>Implementation of the Common Test House for DVB-RCS Terminals</b>	Doc. No: T3-061-v1	
<b>ESA Contract No: 16878/02/NL/US</b>	Version: 1.0	
	Date: 2005-11-13	

Test Case ID	APP_002_01	
Test Case Name	FTP File Transfer	
EN 301790 Reference	8.1.1	
Objective / Test Purpose	Verify correct FTP file transfer over TCP/IP in both directions	
Applicability / PICS		
Initial RCST State	Fine Sync state	
Expected Final RCST State	Fine Sync state	
Test Method	Step	Description
	1	Initiate FTP file transfer at RCST side from FTP server at tester side. File size shall be 10 MByte
	2	Verify duration and retransmissions
	3	Initiate FTP file transfer at test system from FTP server at RCST side. File size shall be 10 MByte
	4	Verify duration and retransmissions
PASS/FAIL Criteria	<ul style="list-style-type: none"> <li>In step 2 and 4 duration shall be less than 10 minutes and no retransmissions shall occur</li> </ul>	
Remarks	<p>The up- and down-link capacities provided to the terminal will be selected at a size, that the 10 MByte file can be transported in reasonable time.</p> <p>Usual error occurrences as they must be expected in usual FTP transmission shall not be deemed as fail criteria for the terminal.</p>	

### 9.17 Variability

In this section the RCST behaviour is tested if number of available CSC slots has changed (on the fly).

#### Reason for having this test

This test should verify RCST's behaviour when changes in burst or framing structure occur while the terminal has already acquired forward link acquisition. The SatLabs recommendation document V0.6 describes several scenarios:

- 1) Reboot
- 2) Re-initialisation (log\_off)
- 3) Reconfiguration on the fly

The intention is to avoid collisions when lots of RCSTs log off because of changes in the forward signalling tables, and re-logon simultaneously. The requirement (stated in SatLabs recommendation document V0.6) is that the RCST should not change its state (e.g. stay in fine-sync state) if the number of CSC slots has changed only.

This section consists of 1 single test case:

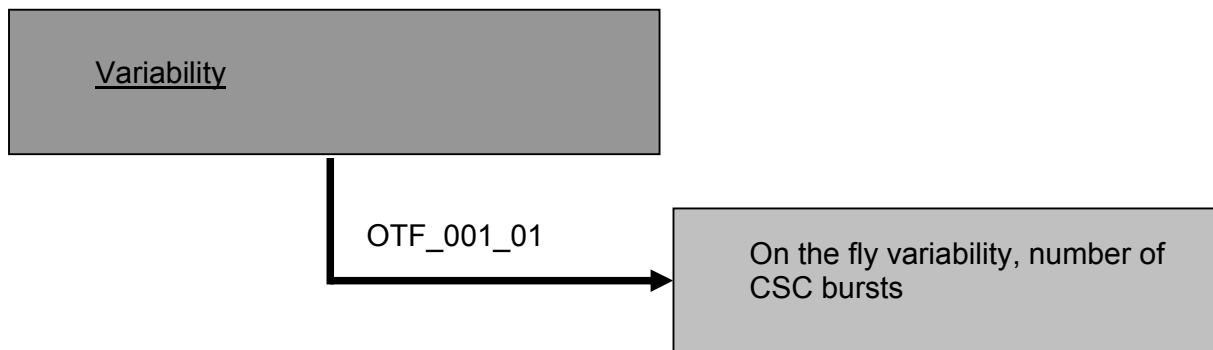

Test Case ID	OTF_001_01	
Test Case Name	On the fly variability, number of CSC slots	
EN 301790 Reference	8.5.5.4	
Objective / Test Purpose	Verify that the RCST is able to handle a varying number of CSC bursts distributed in the TCT without changing its state.	
Applicability / PICS	-	
Initial RCST State	Fine Sync state	
Expected Final RCST State	Fine Sync state	
Test Method	Step	Description
	1	Test system provides a frame/superframe composition that allows the terminal to send CSC bursts in certain slots
	2	Logon Procedure is initiated
	3	Test system verifies, that the single CSC bursts are received in one of the defined CSC time slots.
	4	RCST is expected to enter the SYNC achieved status
	5	Test system changes the frame/superframe composition in a way, that CSC bursts are now located at an area of the frame/superframe, which hasn't been used for CSC beforehand
	6	Test system provides the Table_Update_Descriptor to inform the terminal of the new composition
	7	Terminal is logged off but not rebooted
	8	Logon Procedure is initiated
	9	Test system verifies, that the single CSC bursts are now received in one of the newly defined CSC time slots.
	10	End
PASS/FAIL Criteria	<ul style="list-style-type: none"> <li>• Test procedure is fulfilled.</li> <li>• RCST does not leave fine sync state in step 5</li> <li>• RCST does not leave fine sync state in step 6</li> <li>• RCST is using newly defined CSC positions to start its logon procedure.</li> </ul>	
Remarks	For this test case a superframe composition structure is provided, which has enough "free slots" available to re-allocate the CSC bursts. Parameters that are not relevant for test case purpose, do not have to be changed, like symbol_rate, coding, etc.	

<b>Implementation of the Common Test House for DVB-RCS Terminals</b> <b>ESA Contract No: 16878/02/NL/US</b>	Doc. No: T3-061-v1 Version: 1.0 Date: 2005-11-13	
--	--	---

### 9.18 Wide Hopping

In this section the RCST behaviour is tested if the extended hopping range of 120MHz is used.

#### Reason for having this test

This test should verify RCST's behaviour when the hopping range of 120MHz is used and slots (CSC, SYNC, TRF) are allocated in the extended range (120MHz) by the CTB.

Test Case ID	WIDE_HOPP_120_001_01	
Test Case Name	Wide Hopping Range (120MHz)	
EN 301790 Reference	6.2.3	
Objective / Test Purpose	This test case is to verify that a terminal is capable of handling allocated TRF slots that are up to 120 MHz apart from each other.	
Applicability / PICS	WIDE_HOPP_120	
Initial RCST State	Receive Sync state	
Expected Final RCST State	Fine Sync state	
Test Method	Step	Description
	1	Start RCST logon procedure
	2	Initiate IP traffic from Host PC at RCST side
	3	Test system allocates TRF slots to the RCST with help of the TBTP. The allocated hopping range is 120MHz
	4	Test system verifies RCST's transmit activities. Test system verifies that the RCST is transmitting and using the allocated hopping range of 120MHz.
PASS/FAIL Criteria	<ul style="list-style-type: none"> <li>• Test procedure is fulfilled</li> <li>• TRF slots are used as allocated in the TBTP</li> </ul>	
Remarks	The CTB in its current version is not able to decode TRF slots that are more than 20 MHz apart. Until this feature is available from the CTB transmit activities of the terminal will be assessed in an alternative way. To investigate the terminals transmit activity, the TRF bursts are decoded in one channel and in the other channel the existence and correct length are measured.	

### 9.19 AVBDC

The return link uses a shared medium for several terminals. Therefore a capacity handling is vital for DVB-RCS networks. This section verifies, that a terminal is capable of transmitting error-free UDP traffic by using AVBDC capacity request scheme.

#### Reason for having this test

Capacity in satellite interactive networks – especially in the return channel – is rare. However, to appropriately serve applications a certain data upstream must be guaranteed. To allocate a certain constant capacity is an easy but expensive way to do. Other methods – primarily flexible ones – need to be addressed. DVB-RCS describes several methods of dynamic capacity requests. Only if these methods do follow the determined rules and syntax the overall capacity can be shared between the terminals without collapsing. If a capacity request would not work properly, a terminal would not get a burst allocation to send out its data. The data buffer will overflow and a service provision is impossible. Furthermore, if a terminal requests more bursts than required, capacity is booked for others which would force problems with the overall performance.

Test Case ID	AVBDC_001_01	
Test Case Name	AVBDC Capacity Class	
EN 301790 Reference	6.8.4	
Objective / Test Purpose	Verify quasi error-free UDP packet transmission over the Return Link using the AVBDC traffic class.	
Applicability / PICS	AVBDC	
Initial RCST State	Fine Sync state	
Expected Final RCST State	Fine Sync state	
Test Method	Step	Description
	1	Enable AVBDC capacity requesting at RCST
	2	Test system transmits UDP packets at the Ethernet interface of the RCST.
	3	Test system allocates corresponding TRF timeslots via TBTP upon reception of a SAC field containing an AVBDC request.
	4	RCST forwards all packets via the Return Link
	5	Test system verifies that all packets are received error-free
	6	Test system verifies correct formatting and content of the Capacity Requests in the SAC field of SYNC and TRF bursts
PASS/FAIL Criteria	<ul style="list-style-type: none"> <li>• Test procedure is fulfilled</li> <li>• Error-free UDP packets transmitted in the return link; usual error occurrences as they must be expected in usual UDP transmission shall not be deemed as fail criteria for the terminal.</li> <li>• The SAC fields received for traffic request must be correctly formatted.</li> </ul>	

<b>Implementation of the Common Test House for DVB-RCS Terminals</b>	Doc. No: T3-061-v1	
<b>ESA Contract No: 16878/02/NL/US</b>	Version: 1.0 Date: 2005-11-13	

	<ul style="list-style-type: none"> <li>The RCST is expected to increase the requested volume when the provided capacity is lower than the capacity which is actually required to transmit the initiated traffic.</li> </ul>
Remarks	The terminal is to be configured to allow AVBDC requests.

<b>Implementation of the Common Test House for DVB-RCS Terminals</b> <b>ESA Contract No: 16878/02/NL/US</b>	Doc. No: T3-061-v1 Version: 1.0 Date: 2005-11-13	
--	--	---

## 9.20 Dynamic MF-TDMA

In this section the RCST behaviour is tested if the terminal is able to handle different TRF definitions.

### Reason for having this test

This test should verify RCST's behaviour when adjacent TRF slots allocated to the terminal are different wrt symbol rate and/or frequency.

Test Case ID	DYNAMIC_MF-TDMA_001_01	
Test Case Name	Dynamic MF-TDMA	
EN 301790 Reference	6.7.1.2	
Objective / Test Purpose	This test case is to verify that a terminal is capable of handling different TRF definitions (symbol rates) in adjacent allocated TRF slots.	
Applicability / PICS	DYNAMIC_MF-TDMA	
Initial RCST State	Receive Sync state	
Expected Final RCST State	Fine Sync state	
Test Method	Step	Description
	1	Start RCST logon procedure
	2	Initiate IP traffic from Host PC at RCST side
	3	Test system allocates TRF slots to the RCST with help of the TBTP. The allocated TRF slots differs in frequency and/or symbol rate.
	4	Test system verifies RCST's transmit activities. Test system verifies that the RCST is transmitting and using the allocated slots.
PASS/FAIL Criteria	<ul style="list-style-type: none"> <li>• Test procedure is fulfilled</li> <li>• The terminal uses the TRF slots which are allocated to the terminal.</li> <li>• Traffic can be transported while the terminal shall use adjacent TRF slots that are different in definition (e.g. symbol rates, code rates).</li> <li>• RCST transmits TRF bursts at the expected time and frequency position of the allocated TRF slots (within SYNC thresholds).</li> <li>• RCST is using all allocated TRF slots and only those which are allocated to the terminal (compared to the start slot and assignment count).</li> </ul>	
Remarks	Due to resource savings when designing satellite networks it can be assumed that there are no TRF slots with different symbol rates on one channel. Therefore this test also defines several channels with different TRF symbol rates (one for each channel).	



## 9.21 Contention Sync

In this section the RCST behaviour is tested if the Contention Sync functionality is implemented.

### Reason for having this test

The reason is to allow terminals to send capacity requests without having to wait for the normal SYNC slot and also in the case where no SAC fields are appended to the traffic slots.

Test Case ID	CONTENTION_SYNC_001_01	
Test Case Name	Contention Sync	
EN 301790 Reference	6.6.4	
Objective / Test Purpose	This test case is to verify that a terminal is using the contention based mini-slot method in correct way.	
Applicability / PICS	CONTENTION_SYNC	
Initial RCST State	Off/Standby	
Expected Final RCST State	Fine Sync state	
Test Method	Step	Description
	1	Testsystem transmits SI-tables in order to acquire the FL.
	2	Start acquiring the forward link
	3	Start logon procedure
	4	Verify CSC bursts transmitted by the RCST
	5	Testsystem transmits TIM-U. RCST is allocated normal SYNC slots (without Group-ID and Logon-ID subfield) via Sync Assign Descriptor. The repetition rate of these normal SYNC bursts is very large (> 30 seconds), according to the definition in the Sync Assign Descriptor. Contention based mini-slot method is signalled via Logon Initialize Descriptor.
	6	Contention SYNC slots (with Group-ID and Logon-ID subfield) are signalled via TCT.
	7	Initiate IP traffic from Host PC at RCST side
	8	The testsystem does not transmit a TBTP in order to encourage the RCST to use the Contention Sync slots to request for capacity.
	9	Verify that the RCST uses the Contention Sync slots.
PASS/FAIL Criteria	<ul style="list-style-type: none"> <li>• Test procedure is fulfilled</li> <li>• Terminal uses Contention Sync slots beside the regular allocated Sync slots</li> </ul>	
Remarks		

<b>Implementation of the Common Test House for DVB-RCS Terminals</b> <b>ESA Contract No: 16878/02/NL/US</b>	Doc. No: T3-061-v1 Version: 1.0 Date: 2005-11-13	
--	--	---

## 9.22 Section Packing

Section packing allows for multiple DSM-CC sections to be packed in a single MPEG packet. This entails the termination of one DSM-CC section followed immediately by the start of a second DSM-CC section. Alternatively, several short DSM-CC sections may be accommodated within a single MPEG packet (for example: 1 section terminates, 1 complete section, the start of another section).

### Reason for having this test

The reason is to verify the RCST's section packing on return link as well as the RCST's behaviour on section packing on the forward link.

Test Case ID	SEC_PACK_001_01	
Test Case Name	DSM-CC; Section Packing	
EN 301790 Reference	(ISO/IEC 13818-1)	
Objective / Test Purpose	To check that the RCST is able to perform section packing on return link and handles section packing on forward link correctly.	
Applicability / PICS	SECTION_PACKING	
Initial RCST State	Receive sync state	
Expected Final RCST State	Fine sync state	
Test Method	Step	Description
	1	Start RCST logon procedure
	2	Initiate IP traffic from Host PC at RCST side
	3	Initiate IP-TRF from RCST side in a way that section packing on the return link can be observed. (small packet size, high data rates)
	4	Initiate IP-TRF from testsystem side in a way that section packing on the forward link can be observed. (small packet size, high data rates)
	5	Verify quasi error-free IP-Traffic in both directions
6	Verify section packing in both directions	
PASS/FAIL Criteria	<ul style="list-style-type: none"> <li>• Test procedure is fulfilled.</li> </ul>	
Remarks	The assessment is made by analyzing the structure of transmitted TRF bursts (payload).	

### 9.23 Timing Reference

SatLabs defined that an RCST shall compensate for additional delay that is to be expected (e.g. DVB-S FL processing). Due to different implementations, an additional static delay (maybe positive or negative) is to be applied to guarantee the same level of compensation in each terminal. SatLabs agreed that this additional static delay may be set at the beginning of the SatLabs Qualification testing. The FL settings for this Reference Setting is:

FL-frequency: 11.4879GHz  
 Modulation: QPSK  
 Symbol rate: 8.8888Ms  
 FEC: 2/3

#### Reason for having this test

This test shall investigate, if the terminal meets the timing tolerance as specified in the SatLabs System recommendation, once the additional delay is configured.

Test Case ID	TIME_REF_001_01	
Test Case Name	Variation in FL, correct delay compensation	
EN 301790 Reference		
Objective / Test Purpose	To check that the RCST meets the timing tolerance as specified in the SatLabs System recommendations, once the additional delay is configured.	
Applicability / PICS	-	
Initial RCST State	Idle	
Expected Final RCST State	Ready for Coarse Sync	
Test Method	Step	Description
	1	CTB provides Reference Settings for the FL
	2	RCST is forced to send CSC bursts
	3	Timing deviation between the received and the expected CSC burts is measured
	4	RCST is re-configured to compensate for that timing deviation (delay calibration)
	5	CTB provides Reference Settings
	6	RCST is forced to send CSC bursts
	7	CTB verifies the timing deviation being close to zero (plus/minus few PCR)
	8	CTB provides changed FL settings
	9	RCST is forced to send CSC bursts
	10	CTB verifies that the terminal compensates the changed delay on basis of the new FL settings
11	Steps 8 through step 10 are repeated for several representative FL settings	
PASS/FAIL Criteria	<ul style="list-style-type: none"> <li>• Test procedure is fulfilled.</li> <li>• The terminal sends the CSC bursts within the tolerance as shown in the SatLabs System recommendations for various FL settings</li> </ul>	
Remarks		

<b>Implementation of the Common Test House for DVB-RCS Terminals</b>	Doc. No: T3-061-v1	
<b>ESA Contract No: 16878/02/NL/US</b>	Version: 1.0	
	Date: 2005-11-13	

#### **9.24 NCR Payload**

The default NCR reference time plane is defined to be at the satellite used for the return link. The NCR optional payload may offset this time reference. It is a system decision whether or not to use the optional payload. The RCST should determine the presence of the payload and use the appropriate values if found within it. If the optional payload is absent, the RCST should assume zero values for the delays that can be communicated in the optional payload.

#### **Reason for having these tests**

This test shall investigate, if the terminal is able to handle timing reference points as signalled in the NCR payload field.

#### **9.25 MMT**

Multicasting is an inherent strength of satellite communications and is an important application of the RCS terminals. The support of forward link multicast services in RCS systems is described in section I.6 in TR101790, where the use of the Multicast PID Mapping Table (MMT) is assumed

#### **Reason for having these tests**

This test shall investigate, if the multicasting functionality is correctly implemented.